

1915

nineteen ninety-five

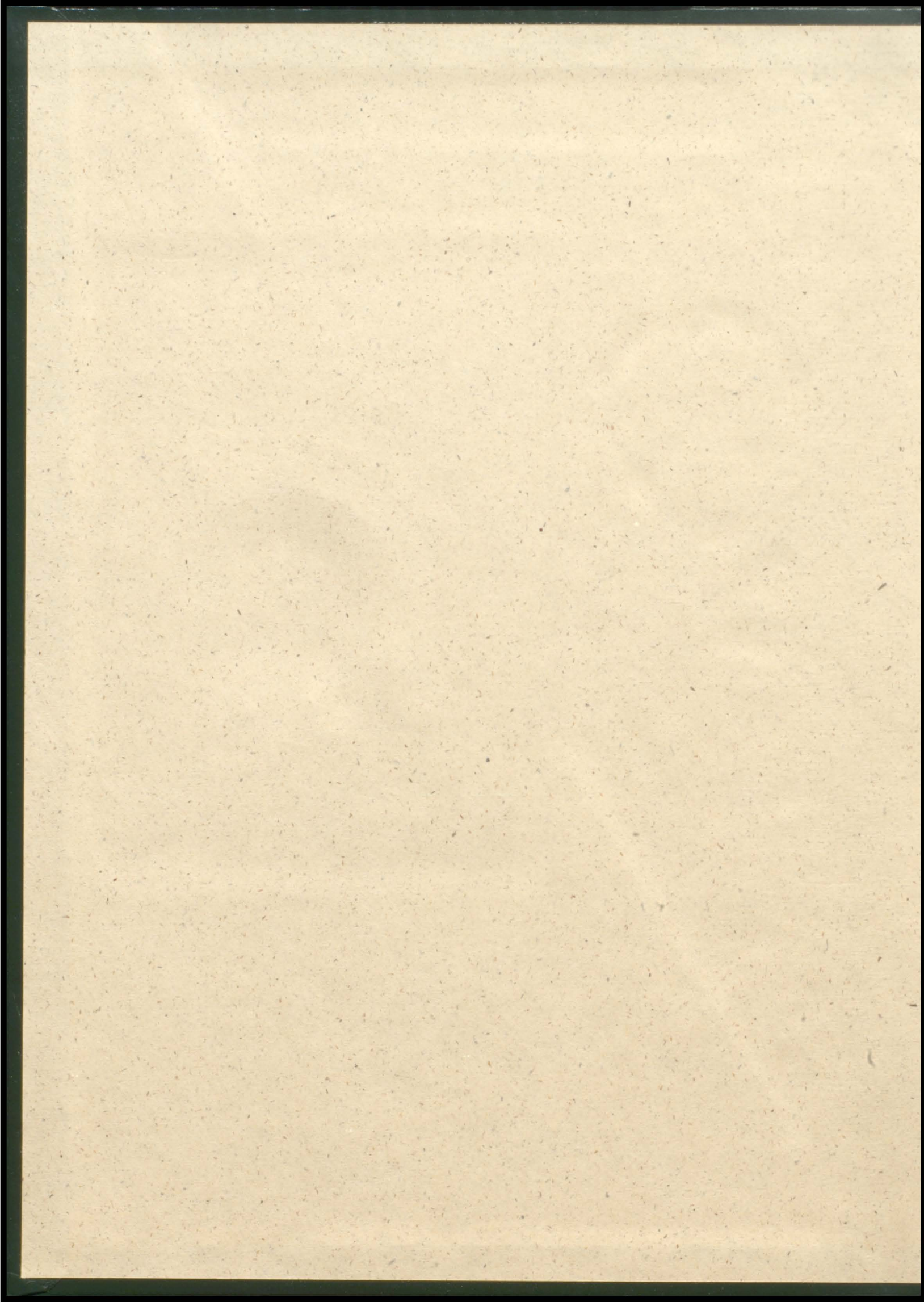

Greenelite







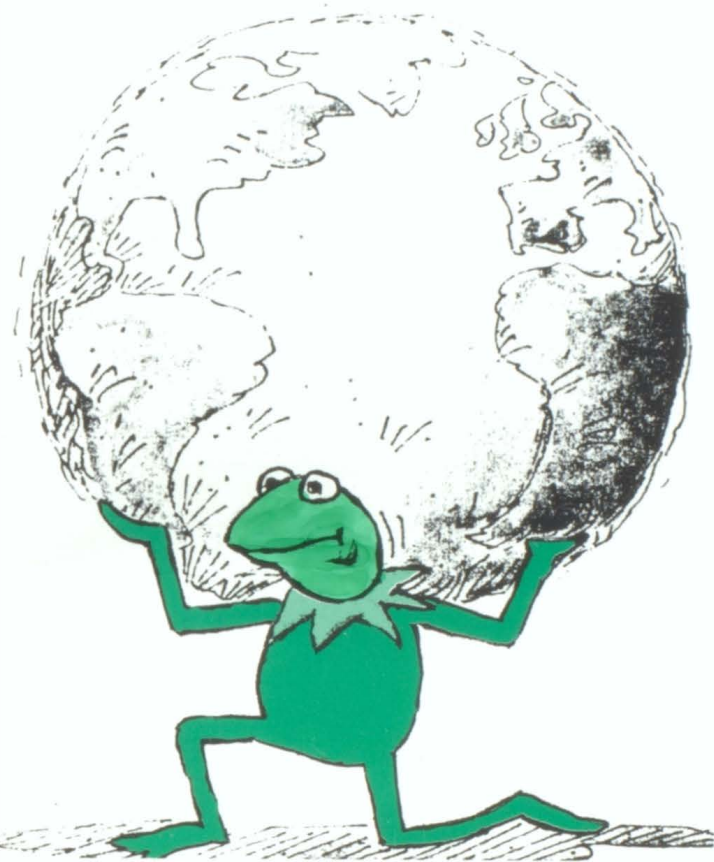

It isn't easy
being
Greene

1995
Greenelite

Greene High School
So. Canal Street
Greene NY 13778
607-656-4161

DEDICATION

Mr. Randy Smith

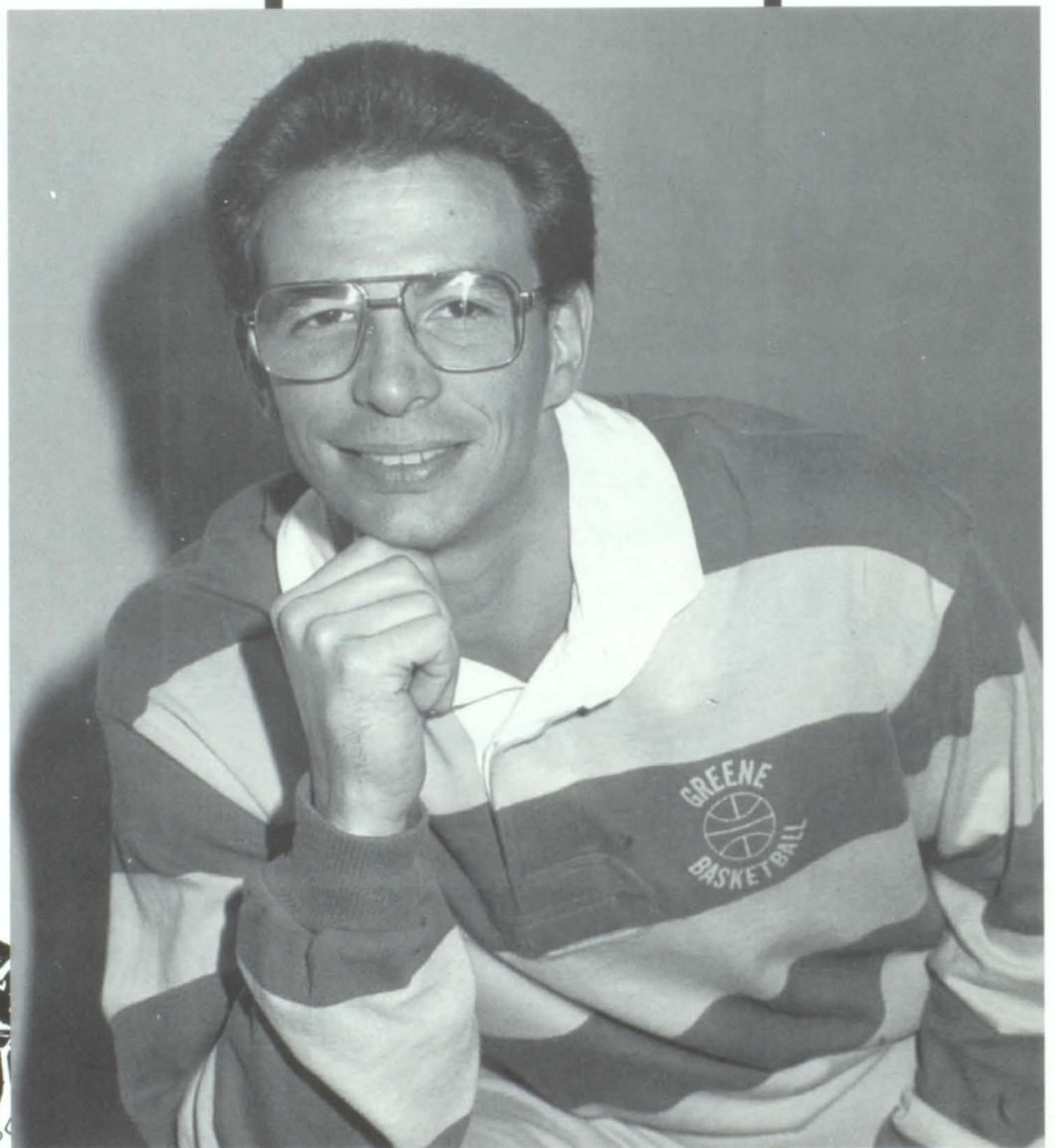

ADMINISTRATION



Mr. Herbert Dickson
Principal
Greene High School



Mrs. Grosso
and
Mrs. Messina
Secretaries
High School
Office



POEM

Written by; April Kenyon

What Is A Friend?

A friend is one who
Understands your moods,
Who knows when to listen
And when to talk.

A friend is a person
Who shares your concerns
And lifts up your spirits
When you feel down.

A friend is caring,
And seldom cross.
She is one to turn to when
Things go wrong.

Find one true pal
On this journey through life.

Trust her
As you would yourself.
There's no greater gift
Than friendship.

SENIORS

"We are here on Earth to do good to others. What the others are here for, I don't know."
— W. H. Auden

CLASS OFFICERS

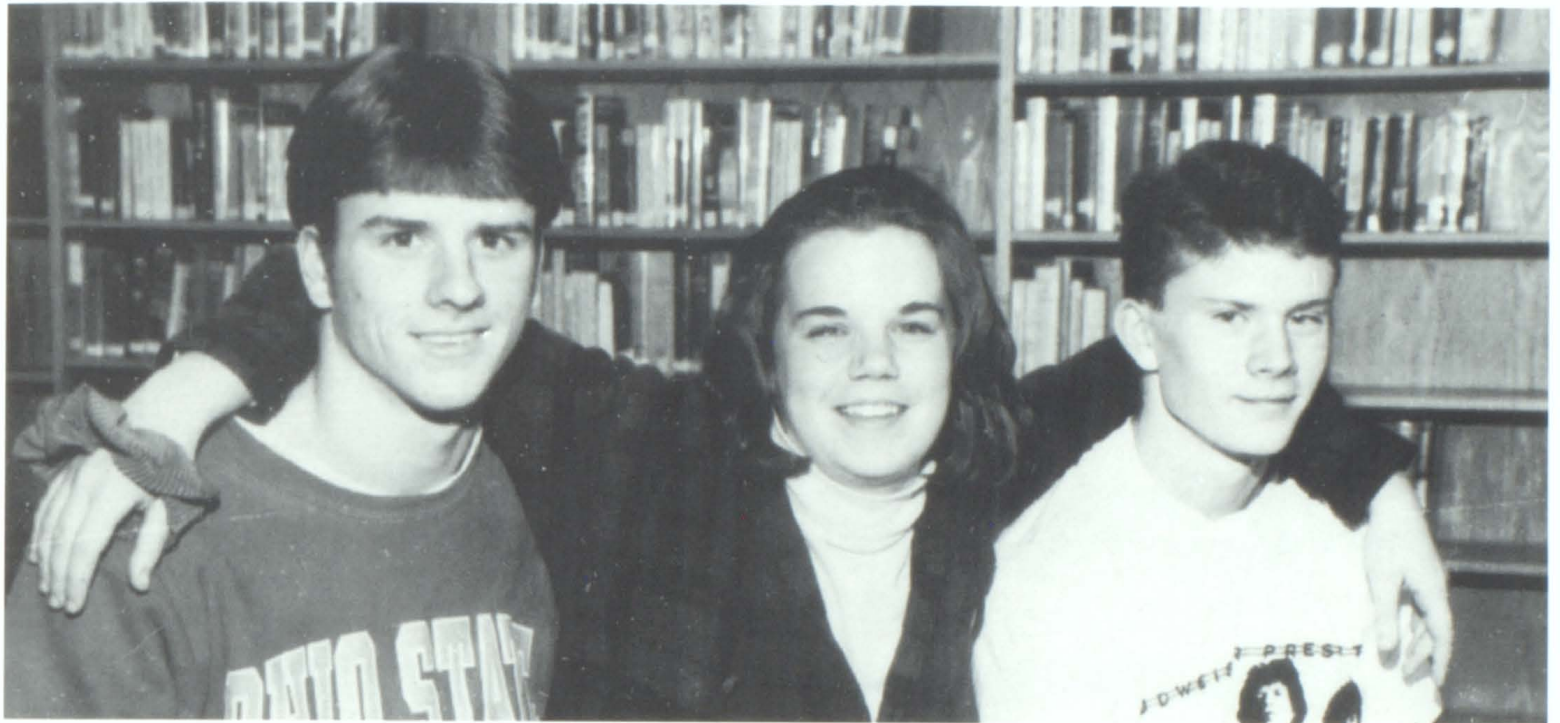

A. Kalicicki, C. Smith, A. Heisler Missing: E. McCabe

STUDENT COUNCIL REPRESENTATIVES

ADVISORS



S. Breslin, M. Hickey, E. Case, D. Burkholder



Mr. Cline and Mrs. Barrows

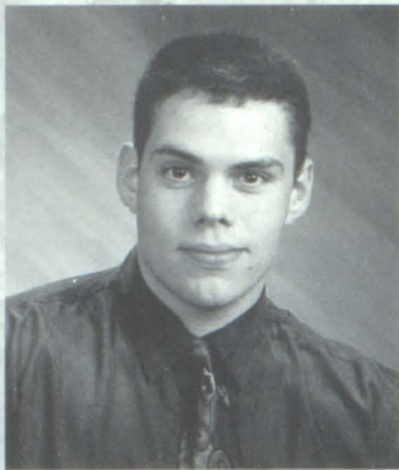

Football 2, 3, 4
Wrestling 3, 4
Golf 2
St. Council 2

Jason Amell

RR#3 Box 144-9
Greene, NY 13778

I Jason Amell leave:
Breslin, swisher, supersoaker, Jake, Neon, hunting trip, Kurt, flatbed
ride, Danny, fast cars, women, bowling, Bobby, new tires, shoe, a
stereo, Carrie, long talks, Livia, a special place in my heart forever, Mr.
Place, from camps to Albany to Friendlys, you the man, I'll never
forget you, thanks.

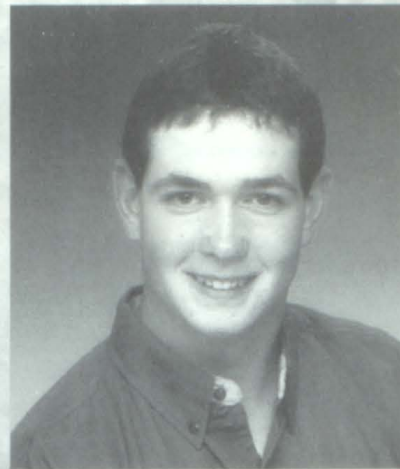

JV Wrestling 1, 2, 3, V
4

Kevin C. Badger

Rd#1 Box A184
Chenango Forks, NY 13746

I Kevin Badger leave; To all my friends and younger relatives to have a
happy life and best of life in the future.



Soccer

Rudy M. Barea



Track 3, 4

Warren Barnes

RD#2 Box 174X
Chenango Forks, NY 13746



No activities listed

Brianda L. Beckwith



V. Football Cheerleading 1, 2, 3
B. Cheerleading JV 1, V 2, 3, 4
Track 1, 2
Tennis 4

Holly S. Beebe

RD#2 Box 522A
Greene, NY 13778

I Holly Beebe leave:

Erin — Maybelline babe, Smithville, Sunflowers; Claudia — 611 foot party; Jessica — happiness; Beth — tennis memories; Livia — lip gloss; Nikki — a shower; Bob — Dolphin's rule!; Josh — a never ending road; Briansa - babysitting me and sneaking in at 4 a.m.; Dan M. "A Real Live Senior"; Carrie — memories; Sam — 2 more years.



V. Field Hockey 1, 2, 3, 4
JV Basketball 1, V 2, 3, 4
Homeroom Rep 4
Girls' Leaders Club 4

Livia Bennett

22 Juliard Street
Greene, NY 13778

I Livia Bennett leave:

Abby, Erin — Bored, Laura — stories, Larkin — Let's win, Gaus — smile!, Seth — mints, Sean — minipads, Beth — sunbathing, Cyr — basketball chats Hall — Hol, Jackson, confused, Christine — crying, Jocelyn — Brooks, Jen-Kiki, Ben — Broken door, Kurt — double dates, Garnar, gazebo, Schoenmakers — "Neighbors!" Jason — Othello! lotsa memories, Luck, Emily — Lifetime of smiles, Party on!



No Activities Listed

Carolyn Bickahm

16 Monell Street
Greene, NY 13778

I Carolyn Bickham leave:

Jennifer Sackett the best of luck in her high school days and much happiness. Mr. Case many thanks for being a good teacher.

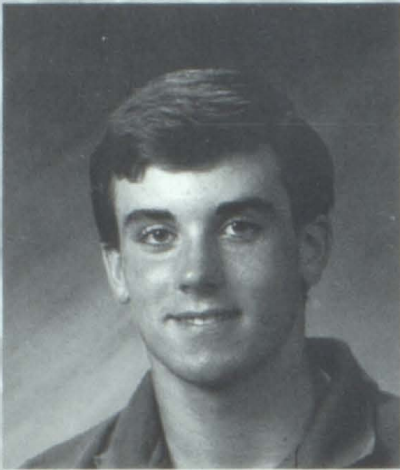

Football 1, 2, 3, 4
 Honor Society 2, 3, 4
 St. Council 1, 2, 3, 4
 Ski Club 2, 3
 Golf 1

Sean R. Breslin

RD#3, Box 259 B
 Greene, NY 13778

I Sean Breslin leave:

Parents — eternal thanks; Coach — gratitude, roller blades; Amell — grilled steak, lucky couches; Kirch — apple stems, dead horses; Liv — mini-surprises; Garnar — blunts, afternoon adventure; Ri — fairy bells, might have beens; Aaron — frisbees, freezing water; Danny, Jake — supersoaking and "highway chics"; Todd — rearranged rooms; Kurt — fish hooks; Shannon — irremovable earrings, appreciation, love.



Chorus 1, 2, 3
 V. Tennis 4 Yearbook
 2, 3
 Footlights 1

Beth Anne Brown

Box 569-B, West Juliard Hill
 Greene, NY 13778

I Beth Brown leave:

Erin: 13 years of cornut trees, "crunch", and German chocolate cake; Claudemeister: white broncos, skating, my unconditional friendship; Seth: holding the door; Brianda and Holly: one boyfriend; Cathy: "Cathyleejobobbill"; Amber: mental help; Johnnie: the remote; Julie & Nettie: love, ambition and a hew hobby; my parents: my love and gratitude.



Football Cheerleading
 1, 2

Rebecca A. Brownell

4 Lucas St.
 Greene, NY 13778

I Becky Brownell leave:

Hali — years of laughter, tears, and great memories; Jamie — Thanks for always being there; Gina — coffee, cards, and late night talks; Laura — a sister and lifelong friendship; John — love with all my heart; Tim — thanks for listening; Sean and April — luck in the future; Mom and Dad — I Love You.

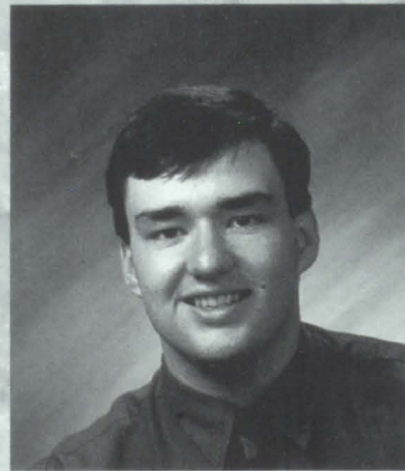

V. Wrestling 1
 Football JV 1, 2, V3
 V Tennis 1, 2, 3, 4
 Class Pres. 1, 3
 St. Council 1, 2, 3, 4
 Yearbook 2, 3, Exec. 4
 SADD 3
 Footlights 3, 4
 Chorus 3, 4

Elden F. Burkholder, III

37 North Canal St., Apt. D
 Greene, NY 13778

I Denny Burkholder leave:

Ben — singing catchy songs; Garnar — we were right: Dukakis; Gaus — Blues Brothers; Breslin — "PUNCH IT!", my conservative sidekick; The "Guys" — thanks for everything; Kristy — long talks and lock-ins; Claudia — happiness, my friendship always; Aubrey — a huge hug, great memories, I'll always be there for you. Fifty words isn't enough.

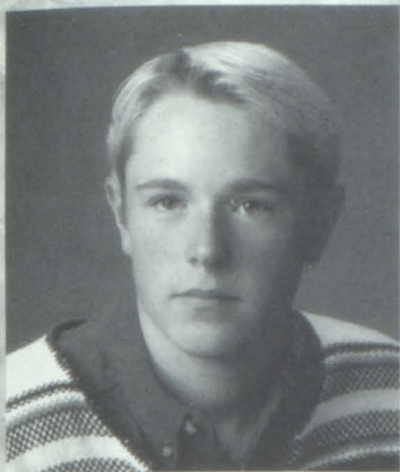

Bowling 2, 3, 4
Volleyball 2, 3, 4
Golf 2, 4

Christopher J. Button

RD#2 Box 765
Greene, NY 13778

I Chris Button leave:

Russ, my car and everything we've gone through, always looking for trouble; Michelle, rides after school; Brian, Brad, and Matt L. going to Harpursville looking for Colin; Clint, staying away from Jessie even though I never wanted to; To my parents, I love you; And I'll miss everyone.



Football cheerleading
1, 2

Hali J. Button

Box 53 G Windham Rd.
Greene, NY 13778

I Hali Button leave:

Becky, friendship always, John, love and special secrets forever no matter what happens, Regina, love and friendship that will never cease no matter how many times you hit me, Jamie, Julie love and luck with families and little squishies, Chris, BOCES bus rides, Family, love and thanks for lessons taught.



Football Cheerleading
JV 1 V. 2, 3, 4
Basketball Cheerleading
JV 1, 2 V 3, 4
Chorus 1, 3
Colorguard 1
Yearbook 1

Stephanie M. Carey

17 Grand St.
Greene, NY 13778

I Stephanie Carey leave:

John six more years at G.C.S., Mary a bunch of straws, Marcia, pepper and fries, Stina, a pound of sugar, Deb, "you're like a sis", Ferg, flowered underwear?, Chet, love and luck, Tonya, Tish, Ashley, all other cheerleaders, many more laughs, Terri happiness with Eric and lets pretend.



V. Track 1, 2, 4
JV Cheerleading 1
Footlights 1, 2, 3, 4
Select Chorus 2, 3, 4
Yearbook 2, 3 Ed. 4

Cathy Jo R. Carter

20 N. Chenango St.
Greene, NY 13778

I Cathy Jo Carter leave:

Em, sugar highs, best friend material, Mr. Right, Dan, My garden fruit, feeling much holy, Karen/Kelly, many hassles, lots of love, Erin, nighttime walks, chronic lateness, Beth, government hairdos BethAnHoboHill, John, Porchtalks, no more nun!, Jennifer/Emily, Pickles Scott, Nemesis, Denny, locker buddy, Greene, Brown-eyed girl.



Girls' Leaders Club 1,
2, 3, 4
Track V2
Softball JV1
Field Hockey JV 1, 2,
V3
Basketball V 1, 2, 3, 4
St. Council 2, 4
Class V. Pres 2

Emily E. Case

21 Juliard Street
Greene, NY 13778

I Emily Case leave:

Laura, Why Hello, Cathy, Jen, pickles; John, Oxford, Aaron, Bugonias; Miss Martin, Nose kisses; "Brenda", Dan, Geraldo; Seth "Kurt-mobile"; "Pppat" TEAM!; Sbbir, Hairstyling; "Airhead", Tall guys; "Neighbors!" Riley, Saida, fulfilling dreams; "Wally", "Ho", Liv, Memories, friendship, hairdryers, Party at Biv!, Kurt, true love, true friendship, whatever lies ahead . . .

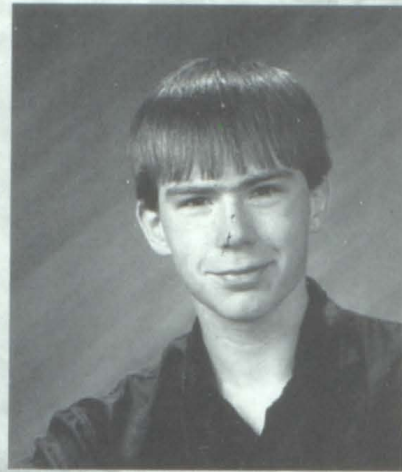

No Activities Listed

Corey Centerwall

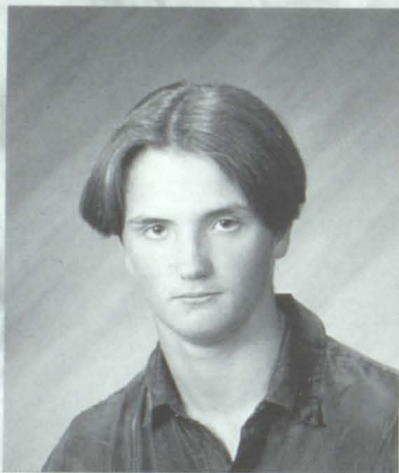

Wrestling V 1, 2, 3, 4
Track V3, 4

Eliot Christy

Rd#1 Palmatire Road
Harpursville, NY 13787

I Eliot Christy leave:

Jake a canning, Erin a shoe in the garbage, Jessica, Froggie, Theresa, Cat woman; Beth, An electric chair; Claudia, Fine knit clothing; Cyndi, 4 more years; Sean, Many more years in a burning inferno; Everyone else, Something that doesn't . . .



Field Hockey JV 1 V 2,
3, 4
Basket ball JV 1, 2 V 3
Girls' Leaders Club 3
Treas. 4
Cheerleading V 4

Wendy Ann Cooper

Box 157c Hogsback Rd.
Greene, NY 13778

I Wendy Cooper leave:

Leslie, A sister, Ben, Memories not forgotten, DaNell, MY name; Livia, A bra; Jason Amell, A hug; Fabulous Four, Suckers, "road trips", memories; Christine, A best friend for life; Carrie Cyr, Hot tub; Jocelyn, Art talks; Dan, A date; Vern, My bed; Shannon, Advice; Aaron, 1:7; Ronnie, A moon.



No Activities Listed

James Crawford

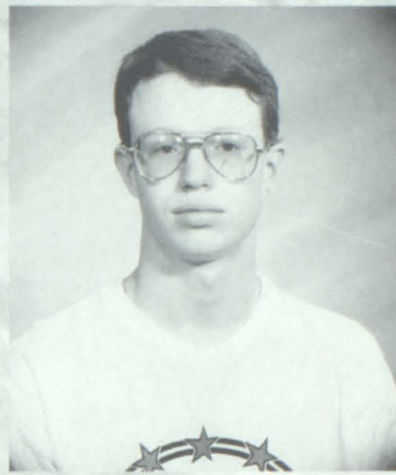

No Activities Listed

Matthew Crerry



Track 1, 2, 4
JV Basketball 1, 2V 3, 4

Carrie L. Cyr

RD#3 Box 247
Greene, NY 13778

I Carrie Cyr leave:
Nikki a great friend (shower), Jess, the moon and stars, Holly, lipgloss, Wendy, Stinky from W.P., Case, on less head on the two headed center, Emily and Liv, a coffee cup, back of the bus chats and luck, Chrissy, I'll leave it up to you, Bob, memories and happiness.



V. Field Hockey 1, 2, 3,
Capt. 4
Girls' Leaders Club 1,
2, 3, Pres.4
Yearbook 2
St. Council 2 Sec. 3
Volleyball JV 1, 2 V. 3,
4
JV Softball 1, 2
V. Track 3, 4

Jocelyn Lowry D'Angelo

193 Cloverdale Rd.
Chenango Forks, NY 13746

I Jocelyn Lowry D'Angelo leave:
Dan, without disappointment; Livia fire, brooks; Emily, "Wally"; Meggy, lifelong friends; Riley, apologies; Ryan, Thanks, _____ at-tack!; Tracy, admiration, RMC, Aaron, gum notes; Carrie, croissant, notebook; Jason, arguing; Wendy, art talks; Mr. Burghardt, smiling; Nick, All my love you never believed in, and happiness I couldn't give you.



Bowling 1
 Colorguard 1, 2, 3, 4
 Chorus 1, 2, 3

Holly B. Diamond

HC 75 Box 996
 Greene, NY 13778

I Holly Diamond leave:
 Kim, a teddy bear named Devin, Terri, I leave my love, a lifetime of friendship and four years of colorguard together, and may nights in Oxford, J.D., Jordan, and Felicia, Six more years of good luck in school and all my love! To all the Seniors, WE DID IT!



Soccer JV 3, V.4
 Track V2, 3, 4

Dan Driscall

63 North Canal Street
 Greene, NY 13778

I Dan Driscall leave:
 Everyone — squat.



Football JV 1, 2 V 3, 4
 Basketball F 1, JV2, V
 3, 4
 Chorus 1, 2, 3, 4
 St. Council 1, 3, 4
 Boys' Varsity Leaders
 Club 4

Benjamin J. Eggleston

56 South Chenango St.
 Greene, NY 13778

I Benjamin J. Eggleston leave:
 Kurt, Todd: Friendship Forever; Christine, Bob, Memories of growing up together; Shannon, happiness, GCS, 3 more Egglestons, Greene V. Football, success; Jason, Dan, Aaron, Scott, one cold night in Smithville; my buddies, one last bonfire; Aaron, our secret punch;; Andy, our skip, Josh, heeya, Livia, a bill for \$25.



Soccer JV 1, 2V 3 4
 Basketball FI, JV2
 Honor Society 2, 3, 4

Todd A. Eldred

RD#1 Box 77B
 Greene, NY 13778

I Todd Eldred leave:
 Aaron, Sean, Scott, one lane bridge, Aaron, Sean, the traffic circle, Sean, the backroads of Smithville, Aaron, a fly on the chalkboard, a twizzler fight, tank, a present from Fido, Laura, a canoe ride.



Field Hockey JV 1, V 2,
3, 4
Cheerleading V 4
Volleyball JV 1, V 2, 3
Track-1, 2, 3, 4
Girls' Leaders Club 1,
2, 3, 4
St. Council 2

Veronica Dawn Flowers

25 South Chenango Street
Greene, NY 13778

I Veronica Flowers leave:
Carrie party shoes; Danelle, life; Fab Bour, road trips, memories,
Christine, friendship, Wendy, a ring, full moon, Jocelyn, my hour,
Shannon, the key, thanks; John, best friends; Jake, everything and
more; Ronnie, my neighbor; Nick, Wendy's room, memories, chewy
cough drops, Byrd, my only brother, my room, I love you.



No activities listed

Robert Fowler

40 N. Canal Street
Greene, NY 13778

I Robert Fowler leave:
Emily & Livia, a sixth sense; Mike & Tony, a boxing match; Schwartz,
carhart vest; Nikki, gas and some salad; Ronnie, a pair of boots,
Donnie, the bookstore,; My parents & Grandparents, thank you, Mr. &
Mrs. Cline, a home away from home,; Carolyn, my eternal and
undying love forever.



Field Hockey JV 1V 2,
3, 4
Girls' Leaders Club 1,
2, 3, 4
Basketball JV 1, 2
Track V1
Band 1
Marching Band 1
Chorus 1, 2
Ski Club 2

Melissa Lynn Frost

RD#2 Box 619-A
Greene, NY 13778

L Melissa leave:
Ron, love; Dan G, last kiss; Danell, sled, Eddie, a friend; Jim, a
motorcycle,; Carrie J, adventure; Mrs. Bromley, respect and character;
Emily C, song in the rain; Clint, eighty percent; Larne H, ninth grade
and a real world; Wesley, good times, love, always hear.



No Activities Listed

BJ Gardiner

PO Box 236
Smithville Flats, NY 13841

I BJ Gardiner leave:
Don, Bobbie, Matt, B another year; Dave, 7 more,; Donnie, a real car,
Bobbie, lots of luck, Curtis, Brad, Mitch anothr, Mitch, R, Button,
Tennent, Ray, another hack game.



Baseball JV 1, 2, V 3, 4
 Basketball JV 1, 2, V 3, 4
 Concert Band 1, 2, 3, 4
 Marching Band 1, 2, 3
 Jazz Band 4
 Senior High Chorus 4
 Student Council 1
 Cross Country 4
 Yearbook 3, 4
 Select Chorus 4

Jason Timothy Garnar

Box 83
 Smithville Flats, NY 13841

I Jason Garnar leave:

Jake, Little League, beanballs at Windsor; Dan, car rides, gazebos, unforgettable memories; Kurt, "White men can jump"; Ben, Lost in Smithville; Corey, running shoes; Scott, Memories of Watson; Aaron, Drinks before practice; Livia, Friends, Harrington, Math memories; Sean, Dynamite, eggs, "inpeccable" conversations; Riley, Respect and Admiration, Seth, 5 more yars.



Football 2, 3, 4
 Basketball 1, 2, 3, 4
 Baseball 1, 2, 3, 4

Daniel J. Gaus

8 Meadow Drive
 Greene, NY 13778

I Dan Gaus leave:

Scott, Aaron, Ben, Garnar-Bad Boys; Kurt — Power Hr; Jocelyn — lost love; Jake, Amell — Adventures; Bob, Mills, CHEW — "BUDDY"; Garnar — Trips, girls, and WILD TIMES; Sean, Neon, Waterides; Riley — SheRa; Livia, "Beautiful"; Carrie, True friendship; Vern — pals; Harv, Scott, Jake, Sean, Garnar — KA — BOOM!; Christine, Wendy; Friends 4 EVER.

Picture
 Not
 Available

No Activities Listed

John Graves



Yearbook 2, 3, 4
 Basketball Cheerleading JV 2
 Football Cheerleading V 3

Karen L. Haines

20 N Chenango St.
 Greene, NY 13778

I Karen Haines leave:

Ashley, Summer days of being followed by guys; Kelly, Many more years of going to Greene; Cathy, Love and luck in college; Chris, The memories of visits and pizza; Mom, All of my love; All my friends, Love and luck in all you do.



No Activities Listed

Chris Hall



Basketball JV 1, 2 V 3
Track JV 1, V 2, 3, 4

Nicole Lian Hall

26 North Chenango St.
Green, NY 13778

I Nicole leave:
Carrie, Luck, happiness with Bob; Jess, All good talks, art class; Emily, Stories on the bus, talks at practice; Liva, Hope and dreams, "Good Wishes"; Brianda, Happy times; Holly, Understanding; Rob, Salad; Jamie/Kelly, The future, "Best of it all"; Mom & Mike, Love you.



No Activities Listed

Fred Harper



Field Hockey JV 1, V 2,
3, 4
Volleyball JV 1, 2
Softball JV 1, 2 V 3, 4
Girls' Leaders Club 1,
2, 3, 4
Yearbook 3, 4

Carrie Ann Harrington

Box 54B1, King Rd.
Greene, NY 13778

I Carrie Harrington leave:
Jocelyn, Trampoline, donuts; Melissa, Windows; Ronnie, Ouervo;
Vern, Real Friendship, Scott; Ryan, A neighbor, childhood memories, a real party; DaNell, A few special friends and memories; Jenn, My name; Rob, A trip; Matt, 5 years and life, GOOD LUCK; Vern, Carrie, DaNell, Summer of 93 . . .



No Activities Listed

Mitchell Harrington



Volleyball 1, 2, 3, 4
Softball 2, 3, 4
Field Hockey 3

Billie Lynne Harris

RR#2 Box 409
Greene, NY 13778

I Billie Harris leave:
Rae, A big thanks, pickles, vaseline, hairspray, manhunts, Jackson
Owego, Subway, bus talks, "B", Thanks for everything, Jessie, A great
last two years, doctor's appointment, Mom and Dad I love you, Bob,
MY everlasting love, my life, my future, and a little tree, our dreams
will soon be fulfilled.

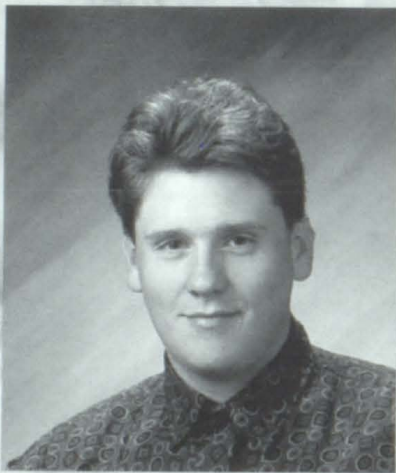

Football 2, 4
Baseball JV 2
Ski Club 1, 2, 3, 4

Joshua Harvey

RD#1 Box 57 King Rd.
Greene, NY 13778

I Josh Harvey leave:
B. Schwartz, Fumble, Pry, About \$20., Ace, Paul, Eiga F, Andy, Ski
Club, best friends, Brianda, Love, the Moon, Livia, Back Rub, Ben, Hi
ya, water Balloons, Sean, Swishers, water balloons, Hoyt, M 80's,
eggs, Garnar & Gaus, Mission Accomplished, Christine, Dreams,
Coach & Team, 8-1 Thanks, Everybody, Bye!



Football JV 1, V 2, 3, 4
Basketball F, 1, JV 2
Track V 1, 2, 3, 4
Nat. Honor Society 2,
3, 4 VP 4
Class VP 4
Student Council 4

Aaron Heisler

RD#1 Box 275-2
McDonough, NY 13801

I Aaron Heisler leave:
Sean, Todd, Scott: Golfing in Cincinatur, Todd: A homemade blender
and other great inventions, Garnar: An unseen devastator, Benny: A
great fighting move, Beth: A two dollar bet, Megan: Violent locker
arguments, Jen: Chin-ups, Laura: Some "original flowers", The Foot-
ball Team: Good luck, Coach Place: Respect, appreciation and NO
REGRETS.



Field Hockey J.V. 1,
2V. 3, 4
Volleyball J.V.1, V.2,
3, 4
Softball J.V. 1, 2 V. 3, 4
Leader's Club 1, 2, 3,
VP 4
St. Council Sec. 4
Homeroom Rep. 4

Megan M. Hickey

RD32 Box 411D
Greene, NY 13778

I Megan Hickey leave: Jocelyn — "Gert", fudge milk, lasting friendship; Aaron — October 28, — attacks, happiness and memories; Riley "Star-Spangled Banner", chocolate chip cookies; Aaron H. Missing me; Meghan — my cadet; Brian — following me; Tracy — without a ride; Michelle and Kris — lots of luck; B-Thanks for everything; My parents — I Love You.



Yearbook 3, 4
JV basketball Cheer-
leading 2
S.A.D.D. 4
V. Bowling 4

Sabrina Holcomb

Jackson Hill RR #1
Greene, NY 13778

I Sabrina Holcomb leave:
Debbie counting down the days, Pheobe and Matt everlasting joy for each other and the baby, Amber and Jaime one more year, Joshua wow you have five more years — watch out for those trees, Christina a spin on Jackson Hill and Mr. Case a big thank you.



V. Wrestling 1, 2, 3, 4
V. Soccer 3 J.V. 2
V. Football 4, JV 1
Track 2
JV Baseball 1

Jason L. Hoyt

P.O. Box 271
Greene, NY 13778

I Jason Hoyt leave
Jocelyn: ambesol, trampoline, juicefalls, Amell, hunting, Harv, Night, Pry and Garnar, one memorable night on the hill, Jenks, respect, Place, thanks, Friendlys, Corey, happiness, friendship, Gaus, a new Taurus, Van Geisen, decrative pipes, Vern, looking to the future, lifelong friendship, hope, "When all is one and one is all" — Zepplin

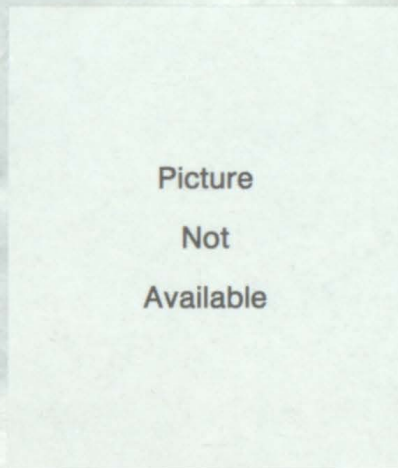

Picture
Not
Available

No activities listed

Kim Hoyt

Picture
Not
Available

No Activities Listed

Thomas Hoyt



Carolyn Jackson

38 North Canal St.
Greene, NY 13778

I Carrie Jackson leave:

Carrie, Veronica, and Anell, Summer of "93"; Veronica, "Sisters"; Tracy "B7"; Wendy, Christine, Tracy, and Livia, Trip to Sidney. Melissa, Joy rides; Dan, A very special friend, Shannon and Stephanie, Good luck! I'll miss you; Jason A, Love and support; Robert, A special place in my heart and love always.

Field Hockey JV 1, 2, V
3, 4
Volleyball JV 1, 2, V 3,
4
Student Council 3, 4
Sec. 4
St. Council Homerep.
3, 4
Girls' Leaders Club 3, 4
Yearbook 3, 4

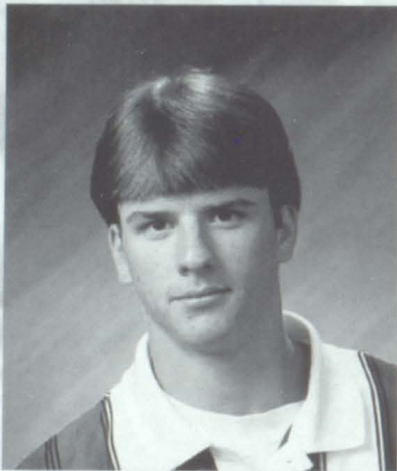

Andrew Thomas Kalicicki

HL 75 Box 949
Greene, NY 13778

I Andrew Kalicicki leave:

Aaron, A bealte; Christine, My loving sister, thanks; Ben, Funky hop; Kurt, Painless touchdown; Nickson, Grid Night; Livia, A movie date; Josh, A broken ski, lightning; Seth and Carrie, 5 years of locker buds; Megan, A backwards dog; Jocelyn, Niggli, oh, my; Emily, Monkeyrub.

Basketball 1
Baseball 1, 2 V 3, 4
Class Officer 4
Sr. High Chorus 1, 2, 3
Ski Club 2, 3, 4

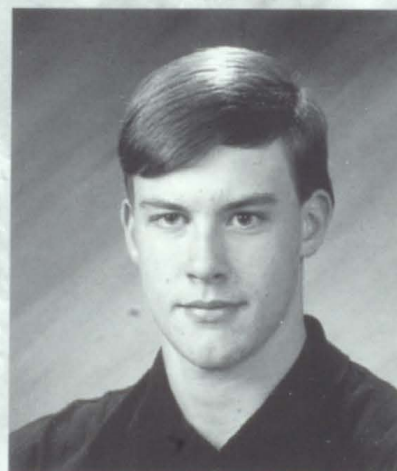

Seth Kirchbaum

RD#1 Box 64
Greene, NY 13778

I Seth Kirchbaum leave:

Sean, 5 years of friendship and a supercharger; Trevor, A weight set and motorcycle; Amell, Screaming "slow down" Riley, Health class and a speeding ticket; Livia, Questioning your moral and "mints"; Brian, Driving a schweet car; Ben, My thanks for a short-lived but great friendship — I'll never forget you.

Football V 2, 3, 4
Golf 1



Golf 1,2,3,4
Basketball Fr. 1
Cross Country 1,2,3
Ski Club 2,3

Aaron C. Kofira

PO Box 124
Smithville Flats, NY 13841

I Aaron C. Kofira leave:
My sister, 2 more years; Bubba, Woman; Mr. Case, In need of a statistician;
Poyer, My sweaters, My parents, My love & gratitude; Girls' basketball
team, Brownies; Woolston, Another round of golf; Jonathan, My Beatles
CDs, tennis match, & a round of golf; Dave, More tennis.



Student Council 1
Class Treasurer 3
HS Challenge 2,3,4
Honor Society 2,3,4
Chorus Accompanist
1,2,3,4
Select Chorus 1,2,3,4
Footlights 2,3,4
Marching Band
1,2,3,4
Jazz Band 3,4

David Madara

4 Scott Avenue
Greene, NY 13778

I David Madara leave:
My locker neighbors: Emily, Prepositions, advice, Muppets; Tracy,
Mahnamahna, The Far Side; Aaron, Your mother's cookies; Brian, Rolling
Stone archives; Dan, A Nashville pillow; Jonathan, Television cart, joyrides
and dandelion fralicking; Riley, Music theory; Matt, A children's choir and
my thanks; Teachers, Respect and gratitude; Everyone, Love and hope.



Volleyball JV 1 v 3
Cheerleading JV 2
Tennis V 3,4
Track V 1,2
Ski Club 3,4
Honor Society 2,3,4
Yearbook 2,3,4
Footlights 1,2,3,4
Select Chorus 2,3,4
Class President 4

Emily A. McCabe

RD#2 Box 594
Greene, NY 13778

I Emily McCabe leave:
Dave, Morning! Mat-nat-mat-na ... Denny, Ryla! Erin, Twin-sisters;
Claudia, Tennis & Nicks; Mimi, Move wiz the ball!; Dan, Smiles & laughs,
irresponsibility & romance that never was; Cathy, friends forever, midnight
walks & munchies raids, summer romances, dilemmas; Beth, Better ched-
der; Tommy, 2 awesome years; Scott, Phone calls, Friends.



Football Cheerleading
V 1,3
Basketball
Cheerleading JV 1,2, V
3,4
Tennis V 4
Track V 1,2
Yearbook 2,3
Footlights 1,2

Erin E. McGrath

4 Monell Street
Greene, NY 13778

I Erin McGrath leave:
Claudia, Dog Biscuits in the mail box. Poohie: Maybelline babed, Smithville; Bronda,
My babysitter, death to Richard Craniums; Beth, Everything, phases behind trees; Pliv,
Rabin Stations, long walks, sledding; Nermal, A sister; Colin, My scrunchies;
Johnathan, Locked lockers; Jason, A rose; Amber, Aaron,; Felice, Always your gurgle.



Cross Country V 2,3,4
 Track V 2,3,4
 Basketball 1,2
 Bowling 3,4
 Golf V 1
 Volleyball 3,4
 Indoor Track 4
 Band 1,2,3,4
 Marching Band 3,4
 Chorus 1,2,3,4

Brian E. Mellem

RR#1 Box 508
 Greene, NY 13778

I Brian Mellem leave:
 Jeremy, A collection of discottits; Dustin, A polyester jumpsuit; Dave C, A fishstick; Dan D, An Acme portable hole (use it wisely); Nicole, A wig; Dave M, The month of "April"; Mr. Hall, A strange Uncle in his closet; Jeremy, Val, Brandy, Gondola B; I have five words left!



No Activities Listed

Lindsay Rae Messina

Stillwater RD#1 Box 499
 Greene, NY 13778

I Lindsay Messina leave:
 Shayne, Seth & Jeff, Hang in there, the best is yet to come; Mom and Dad, Thank you for all your patience and understanding through the years; Elaine, Unforgettable days in the lounge; Nicole, Jaime, Renee, What Next??; To the Class of '95, The future is finally ours to seek out!



No Activities Listed

Ondraia Moore

HC 75 Box 914A
 Greene, NY 13778

I Ondraia Moore leave:
 Liza, I leave my strength, keep it real; Emily, friendship; Riley, Mom; Chris, (secret) congratulations; Jocelyn, "Good Mommie" !?!?!; Dan, You're so cute; Scott, My best friend; Em & Ri, The club; Greene Central School, I will always love you NOT.



Tennis V 2,3,4
 Volleyball 1
 Chorus 1,2,3
 SADD 2

Claudia Ann Oliphant

Hotchkiss Hill RR#1 519B
 Greene, NY 13778

I Claudia Ann Oliphant leave:
 Bob, My heart to have forever; P.W., I love you!; Bethy, Weights and a white Bronco; Lynnette, Hugs, tears, and duck tape; Erin, A blind date; Holly, "I know you:" Denny, You're right; Corey, Ears; Seth, A scooter; Jessica, The floor at Loews; And Alan 4 years of LUCK!



No Activities Listed

Jonathan W. Owens

PO Box 172
Smithville Flats, NY 13841

I Jonathan Owens leave:
Tabitha — 1998; Samantha — 2002; Jacob — 2009; Matthew 2011; My
parents — Love and respect; Aaron K — real sports, music, think long-
term; Jeremy — A joke; Dave — A true friend; Erin — a locked locker;
Mrs. Taylor — An errand; Mr. Place-Video taping expertise; Mrs.
Schuchman — Many thanks; To all — a successful career.

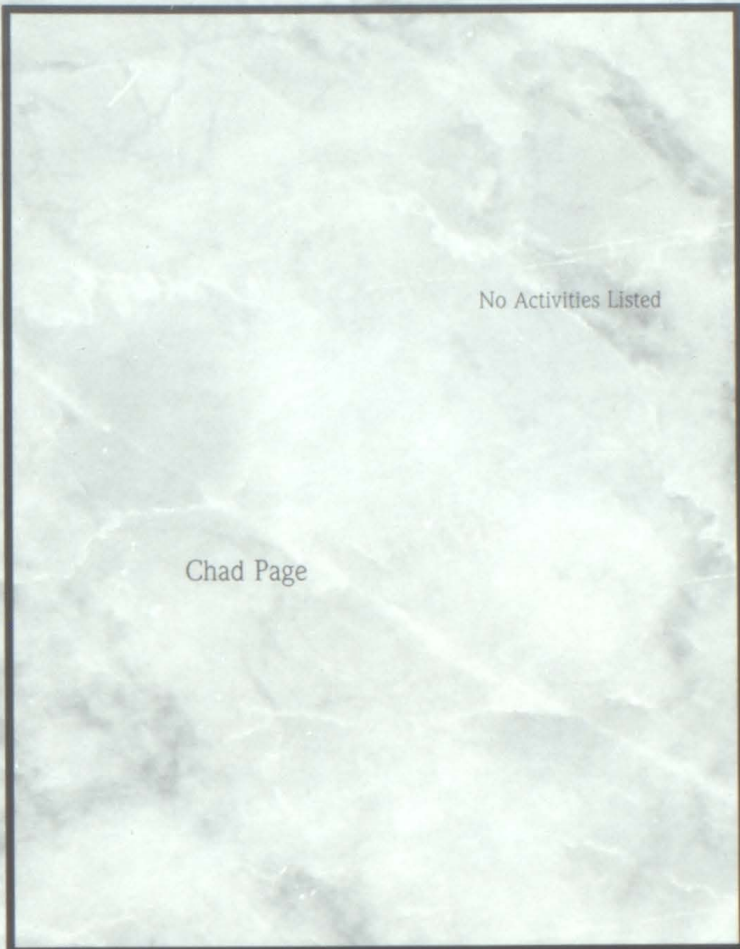

No Activities Listed

Chad Page

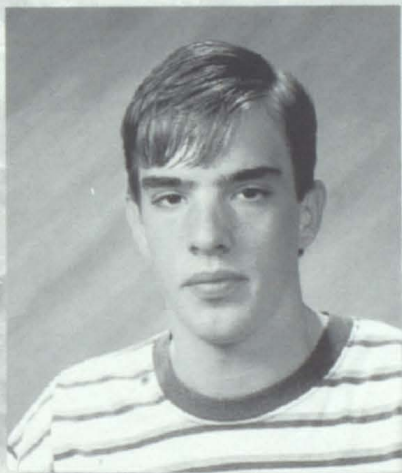

No Activities Listed

Rob B. Palmiter

Box 418A RTE 12
Greene, NY 13778

I Rob B. Palmiter leave:
C.H., A friendship forever, The Runi, MY respect; E.S., An appreciated
friendship; AR An apology; S.M., Summer of 93; M.V., The Bronco,
Thanks for always being there; O.K.H., Legends; C.S., My love, Many good
memories; D.Z., A quality trailer party.



No Activities Listed

Chris Marie Penny

R.R.#1 Box 520
Greene, NY 13778

I Chris Penny leave:
My happiness to Mrs. Ferguson and Mrs. Cline for being a great help to me
through the years, all my books for the Class if "96", my love for all the
lovely teachers that put up with me, my luck to my sisters, and everybody
else through the years.



Field Hockey JV 1V2,
3, 4
Basketball JV 1, V2, 3,
4
Softball JV 1, V 2, 3, 4

Jennifer Rose Pratt

RD#3 Box 529
Greene, NY 13778

I Jennifer Rose leave:
Cathy, Pickle; Emily, Back of the bus stories; Livia, A double date;
Kurt, A toga party; Aaron H and Scott, A chin up; Aaron Pry,
partnerless; Jason Amell, A piece of gum; Veronica and Christine,
Keith; Keith, All the stars in the sky and much, much, more!



Basketball JV 1, 2 V 3,
4
Soccer JV 1, 2 V 3, 4
Track V2
Tennis V 1, 3, 4

Aaron J. Pry

7 Birdsall Street
Greene, NY 13778

I Aaron J. Pry leave:
Mel, One more year in my shadow; Bad Boys' Club, Many more nights
ahead; Harvey, Rearview mirrors; Jimmy, Jake, You should of; Wendy,
I tried; Jocelyn, Gum wrappers; John, Hartwick, more adventures
ahead; Emily, Blueberries; Gretchen, Camping, fireworks; Andy, Num-
ber thirteen; Megan, Unforgettable Senior year with many more —
Attacks Ahead.

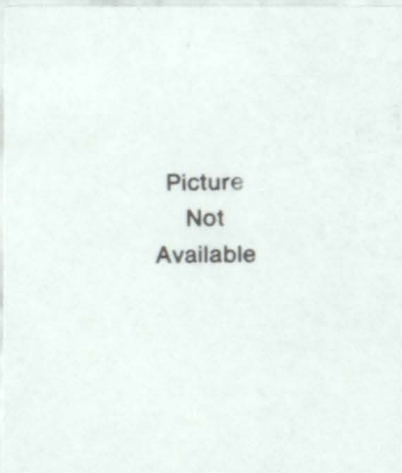

No Activities Listed

No Activities Listed

Mitchell Race

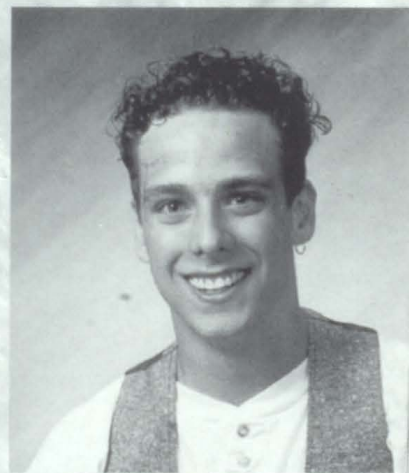

Footlights VP 1, 2, 3,
4
Chorus 1, 2, 3, 4
Band 1, 2, 3, Treas 4
Select Choir 1, 2, 3, 4
Marching Band 1, 2, 3
All State Choir Alt. 3
Paart 4
Academic Challenge
Team 1, 2, 3, 4
Student Council VP 4
Peer Counselor 4
Yearbook 1, 2, 3, 4

Dan Richter

Box 254A RR#3
Greene, NY 13778

I Dan Richter leave:
Emily, A platonic relationship, yawns, ice cream, the kiss that never
happened; Cathy, Cheesy pickles, garden fruit, gratitude, cheesecake!
Kurt, Mowed lawns and a keyhole; Livia, My heart; Supdweedgirl,
Free Mochalattas; Riley, Fairies, milkweed, a studio apartment, re-
spect; Smurfette, Nutritious women; Olivia, Theresa, My "bootocks"
and kisses; Amy, Support groups.

No Activities Listed

Ray Root



Student Council 1,2
Sec. 3, Pres. 4
Footlights 1,2,3,4
Girls' Leaders Club
1,2,3,4
Yearbook 1,2,3
Volleyball JV 1,2
Honor Society 2,3,4
AIDS Awareness
Group 4

Riley Anne Salyards

HC 73 Box 22
Smithville Flats, NY 13841

I Riley Salyards leave:
Dan, A Broadway role, Scott, A date with Ani, Carrie, Now and later, Megan,
Star Spangled Banner, Ms Molly, Mochas in Europe, Dan, HeMan, J.R., Sweater
boy, Saida, Emily, "The Club", Seth, Passing me, Mrs. Philippone, Fairy
children, Jocelyn, Penguins, love, Sean, The I love you I couldn't say.



Football JV 2, V 3,4
Basketball FR 1, JV 2
Tennis 1
Golf 3,4
Band 1,2
Honor Society 2,3,4

Jason John Schoenmaker

1 Turner Street
Greene, NY 13778

I Jason John Schoenmaker leave:
Mom & Dad, All my respect; Andrew & Mindy, A few years left; Dan, Nature hikes,
late night Nintendo; Bob, Car rides; Chris, A taste of classic rock; Amell, Football;
Breslin, Squirtin; Kurt, Crutches; Riley, Beautiful; Wendy, Prom buddies; Livia,
Neighbors; Christine, Friends & Enemies; Vern, Cough Drops; Nick, Golf.



Field Hockey V 2
Yearbook 3

Jessica L. Sensbach

Box 172-F Bowbell Rd.
Greene, NY 13778

I Jessica Sensbach leave:
Tracy Jane, Best Friendship, Paris, Greenwood Lake, Lush, Mary Moon, Ranger Dick,
Darien Lake and locked in keys, camping trips and multicolored tent, sitting in town,
sidewalk chalk, almost Woodstock; Beth O, Concerts we never went to, a good friend;
Carrie, Nikki, Great art classes; Claudia, Friendship, good advice.



Football JV 1, V 2,3,4
Basketball 1, V 4
Wrestling 3
Golf V 1,2,3,4

Robert Lee Shevlin, Jr.

6 Jeffery Hts.
Greene, NY 13778

I Bob Shevlin leave:
MC, A driving lesson; DG, Fun times (mills)!; SB, Another practice;
KW, Red lights; JS, Memories of the Wu Tang; Carrie, Good times
together; NH, Prom night; And to my parents, All the minutes I owe
you! I love you both!

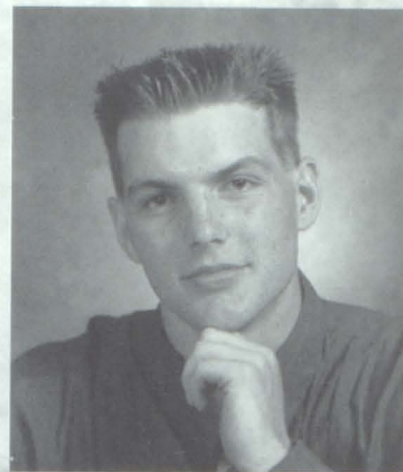

Football JV 1 V 2,3,4
Basketball JV 1,2 V
3,4
Track V 1,2
Footlights 2
Student Council 1,2,3
Chorus 1,2,3,4
Band 1,2,3,4
Marching Band
1,2,3,4

Todd Ray Short

RD#1 Box 139 Shafer Road
Harpursville, NY 13787

I Todd Short leave:
Kurt and Ben, Friendship until we die, a trip to California in the truck,
and love, Good luck at Cortland, maybe you guys can join me
someday. I love you guys.

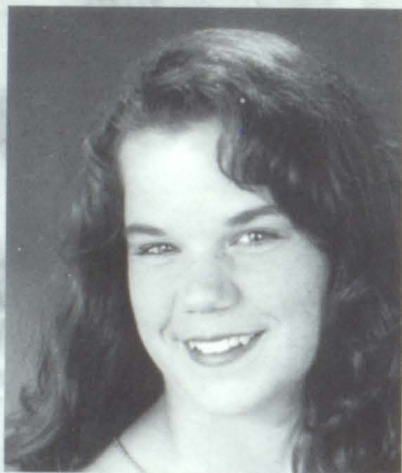

Field Hockey JV 1,2 V
3,4
Basketball JV 1,2
Track V 2
Cheerleading V 4
Class President 2
Leaders' Club 2,3, Sec.
4
Class Treasurer 4
Chorus 1,4

Christine Ann Smith

PO Box 545
Greene, NY 13778

I Christine Smith leave:
Fabulous Four, Suckers; Wendy, Best friends for life; John, Truck,
buddy; Cyr, Grabbed; Jimmy, Memories; Kurt, Car; Ben, Love ya
always; Jake, Prom; Bobby, Punch; Shannon & Katie, Love ya; Har-
rington, Gossip; Carter, chapstick; Larkin, Laughs, step-master; Zeck,
Love ya, kalicicki, a sister that loves you; Jackson, friends!

No Activities Listed

Stacie Smith

Football V 3
Baseball JV 1,2

Jason Tennant

23 N. Canal St.
Greene, NY 13778

I Jason Tennant leave:

All the crazy teachers and all their nagging to all that comes this far in Greene High. So in short — GOOD LUCK!! Teachers! Mitch Race, Nikki Hall, Ray Root, tools for BOCES! Mom & Dad, The good times.



Baseball JV 1 V 2,3,4
Bowling V 1,2,3,4
Varsity Club 4

Ronald Joseph Utter Jr.

21 South Chenango Street
Greene, NY 13778

I Ronnie Utter leave:

A big thanks to Mr. Burghardt and Mr. Cline; Nick, Many good times, good luck with everything; Christine and Wendy, One more night on the porch; Carrie and Rob, One more party; Melissa, A real boyfriend; Jocelyn and Vern, Labor day; Steph, Mutual fellings; DeNell, Fonzie bear; Fowler, Boxing match.



No Activities Listed

Leslie J. Valentine

PO Box 453
Greene, NY 13778

I Leslie J. Valentine leave:

All my books to the Class of '96, to study with; All my love to Mrs. Cline, Mrs. Ferguson, Mrs. Neudel, and Miss Bertram. You have all been great friends and great teachers to me. I will miss you all.

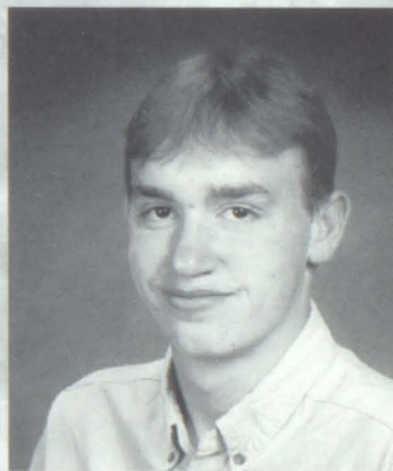

No Activities Listed

Michael Vanderbunt

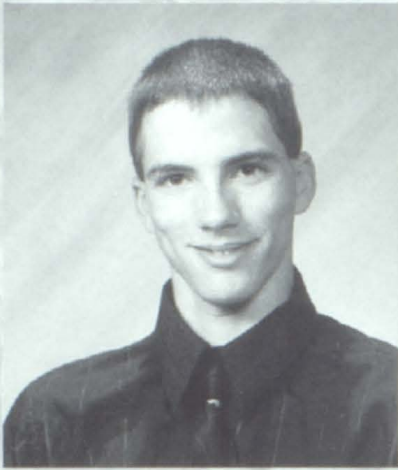

No Activities Listed

Justin J. Vanderweyde

RD#1 Box 271 A
McDonough, NY 13801

I Justin J. Vanderweyde leave:
Greene Central High School with lots of memories. Ever since I moved here
in 9th grade, I have learned alot from two teachers (Mrs. Ferguson and
Miss Bertram) then I ever had on Long Island. See Ya! in the funnies.



Chorus 2,4
Select Chorus 4
Yearbook 3,4

Scott Van Giesen

PO Box 19 Rt. 41
Smithville Flats, NY 13841

I Scott Van Geisen leave:
Dan, A sleeping bag; Riley, Sunfloweres and many Capios; Jason, A ship;
Shoe, The mills; Heisler, Breslin, Eldred, A one land bridge, Livia, Emily,
An organ; Ben, Where are you!?! Pry, A designated driver; Jake, Dynamite,
Corey, A razor; My razor; My friends, I'm going to miss you all.

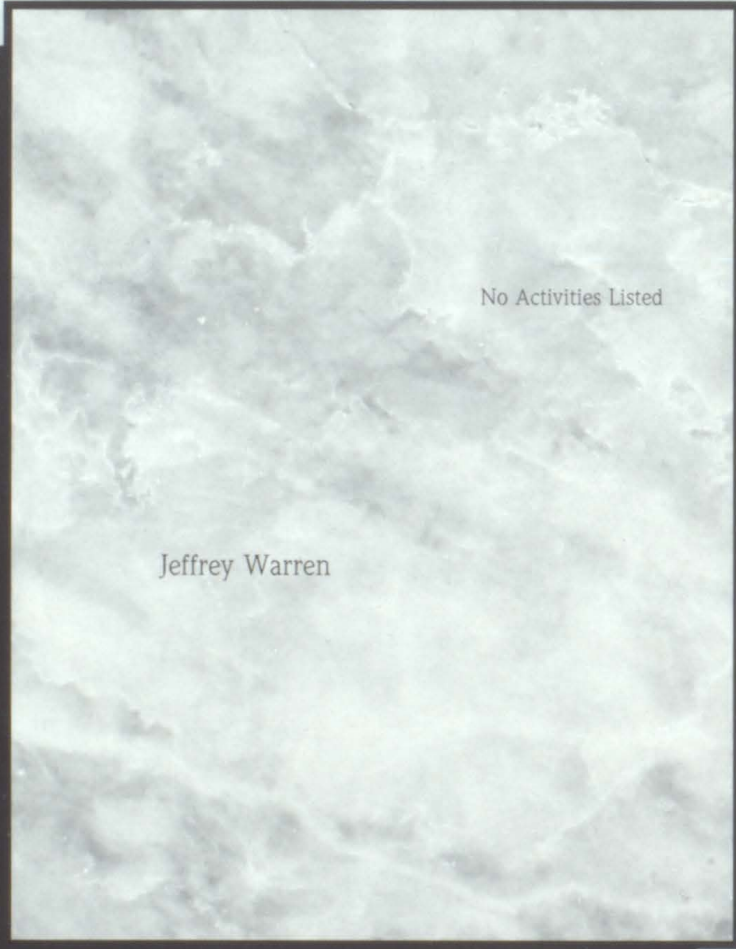

No Activities Listed

Jeffrey Warren



Soccer JV 1,2 V 3,4
Football V 4
Basketball JV 1, V
2,3,4
Track 1,2,3,4
Varsity Club 4
Student Council 2,3
Band 1,2,3,4
Marching Band
1,2,3,4
Chorus 2,3,4
Select Chorus 4
Jazz Band 4

Kurt N. Weir

HC 75 Box 982
Greene, NY 13778

I Kurt Weir leave:
Todd, Bestfriends; Ben, 4 years at Cortland; Corey, A good ankle; Dan,
Power hour; Dan, A key; Parents, Love and thanks; Livia, Private talks;
Amell, Football; Sean, A race; Mr. Burghardt, Respect and gratitude;
Emily, 4 years of love and memories that will never be forgotten.



No Activities Listed

Melissa J. Wells

RR3 Box 248 Page Brook Rd.
Greene, NY 13778

I Melissa Wells leave:



No Activities Listed

Shelly Wheeler



Chorus 1, 2, 3
Track 1
Footlights 1

Elaine L. White

Miles Road RR#3
Greene, NY 13778

I Elaine White leave:

S.R., A wheatthins box, an everlasting friendship, and animal noises;
L.M., life; R.F., One last walk in the rain; A.S., A tissue and fake nails;
M.W., One last slow dance; T.B., Catwoman; Mom and Dad, I made
it, Thank you; J.B., Great memories.



Cross Country 1, 2, 3
Track 1, 2, 3

Wanda Whitmore

PO Box 15
Smithville Flats, NY 13841

I Wanda Whitmore leave:

My sister, Peggy Kenyon, the books and all the fun and grief of school
to you, but just remember you only have 12 more years. To my
mother, I leave the knowledge that she helped me and encouraged me
through school. Remember Mom, I will always love you.

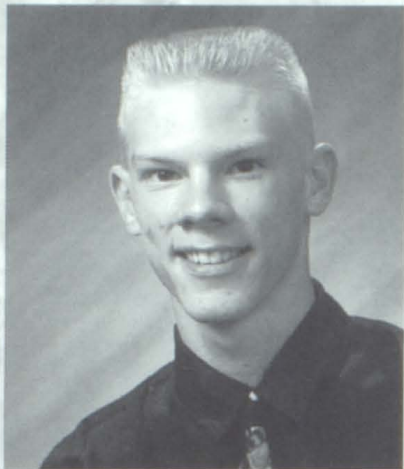

Soccer 1, 2, 3, 4
Basketball 1, 2, 3, 4
Track V 1, 2
Tennis V 4

Timothy P. Winston

RD3 Box 165A-W
Greene, NY 13778

I Tim Winston leave:

Aaron, 7.3, a window, more girls; Rob, The flat wagon; Christian, A guy, a brother forever; Riley, Cappacino in that cafe, a friend; Megan, love; Ben: one last "hey Ben"; Laura, Newspaper, roses, love and luck; Mom and Dad, Love and thanks; GCS, "Goodbye."



Soccer JV 1, 2, V 3
Golf 1, 2, 3, 4

Christian W. Woolston

Box 718 Indian Brook Rd.
Greene, NY 13778

I Christian W. Woolston leave:

Niggly, Two more years of Greene babes; Ehler, You wanted it, Be good!; Schoenmaker, A taste of classic rock; Pry, Five crackers, shopping sprees; Shevlin, A hole in one; Kofira, Trip to the track; Nicole, Whatever reality has brought us, hopefully my love, definitely memories, intellectual knowledge, wonderful experiences, and love.



Ski Club 2, 3, 4
Track V 2, 3, 4
Soccer JV 1

Jeremy Young

PO Box 132
West Juliard Hill
Greene, NY 13778

I Jeremy Young leave:

Valorie, My love and vermicious kannids; My brother, Dustin, An eternity of torture, tax free; Dan and Aaron, A life (in the kindest sense of the word); Jake, Scar healing kit; Class of '95, A happy fun ball, and some pocket fuzz, I only have eight words left to write.

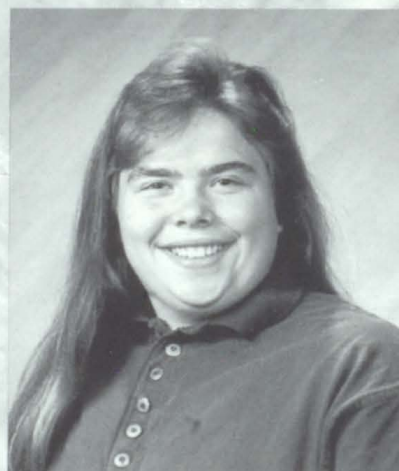

Field Hockey JV 1, V2,
4
Basketball JV 1, 2
Softball JV 1, V, 2, 3,
4
Student Council 1, 2,
4
St. Council Homereps
1, 2, 4

DaNell Zeck

I DaNell Zeck leave:

CH, CJ, VF, Summer of '93; Christine, 2nd mother; Rob, A party; Wendy, A driving lesson; Melissa, Day out in the Bronco; CH, The best of memories.



Cheerleading 1, 2, 3
 Field Hockey V 2
 Yearbook 3
 Volleyball 1

Tracy J. Layman

PO Box 173
 Greene, NY 13778

I Tracy Layman leave:

Greene early; Mrs. S, Thanks; Jess, Box 5, future addictions, pete n' pete; Jeremy, from my microwave; James' letters, sittin in town, Woodstock, looking horizontal, everyone just like you and the best friend IN THE WORLD and stuff; Jen, Marcia, Claudia, Dave, and Becky, Friendship, keep in touch; Everyone, God.



Frog Football 2, 3
 Amphibian Leaders' Club 1, 2, 3, 4
 Pond Hockey 4
 Muppet Council 1, 3, 4

Kermit T. Frog

123 Sesame Street

I Kermit T Frog leave:

Swedish Chef, "Bork, bork, bork"!; Ralph, My tiny running shoes; Animal, New drums; Zoot, One cool cat; Grover, One last "hi-ho!"; Gonzo, Respect; Fozzie, Best pals forever; Piggy, "Kermie" cuddles, "Pigs In Space"; It's not easy being green in Greene!



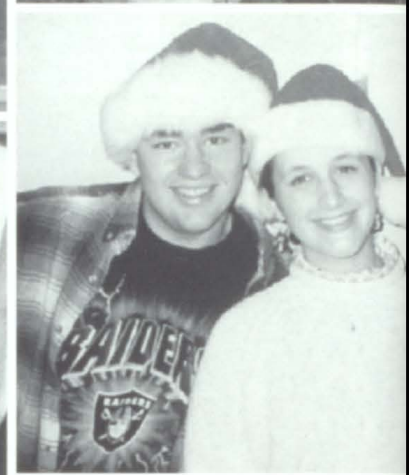
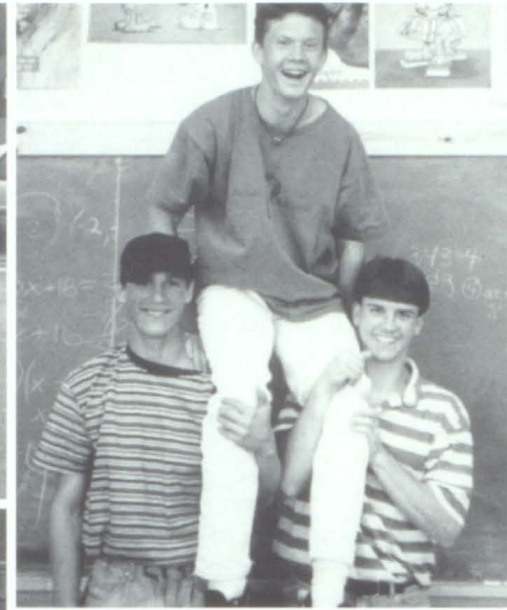



CLASS COUPLE

K. Weir and E. Case



PERKIEST

E. McCabe and D. Richter

SHYEST

M. Crerry and J. Sensbach



PARTY ANIMALS

D. Zeck and R. Ralmatier (missing)





BEST LEGS

M. Hickey and B. Eggleston

MOST ATHLETIC

J. Hoyt and J. Pratt



MOST MUSICAL

D. Madara and R. Salyards

EVERYONE'S FRIEND

D. Burkholder and L. Bennett



BEST DRESSED
C. Button and R. Salyards



CLASS CLOWNS
D. Zeck and A. Kalicicki

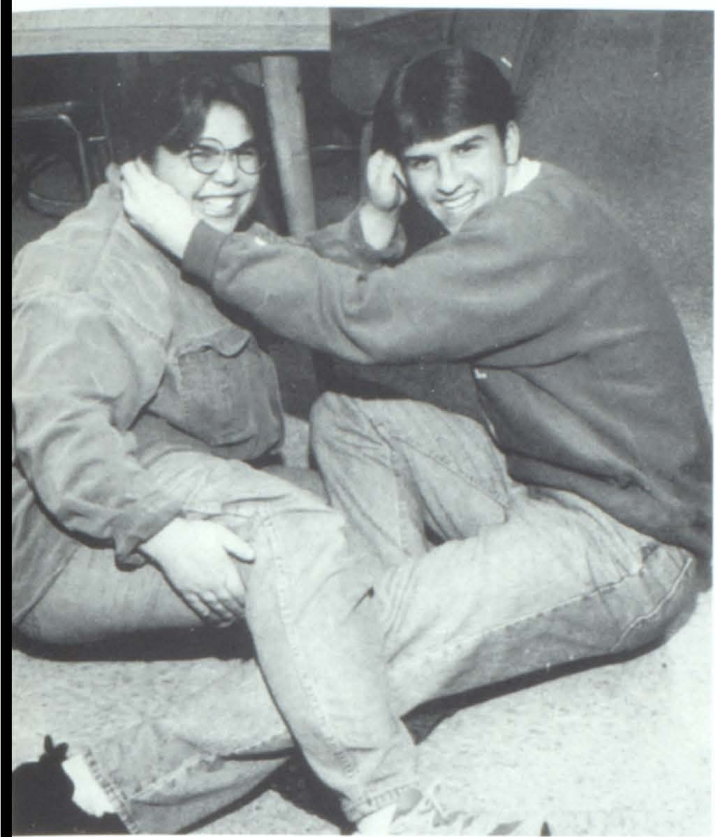

MOST SCHOOL SPIRIT
D. Burkholder and C. Smith

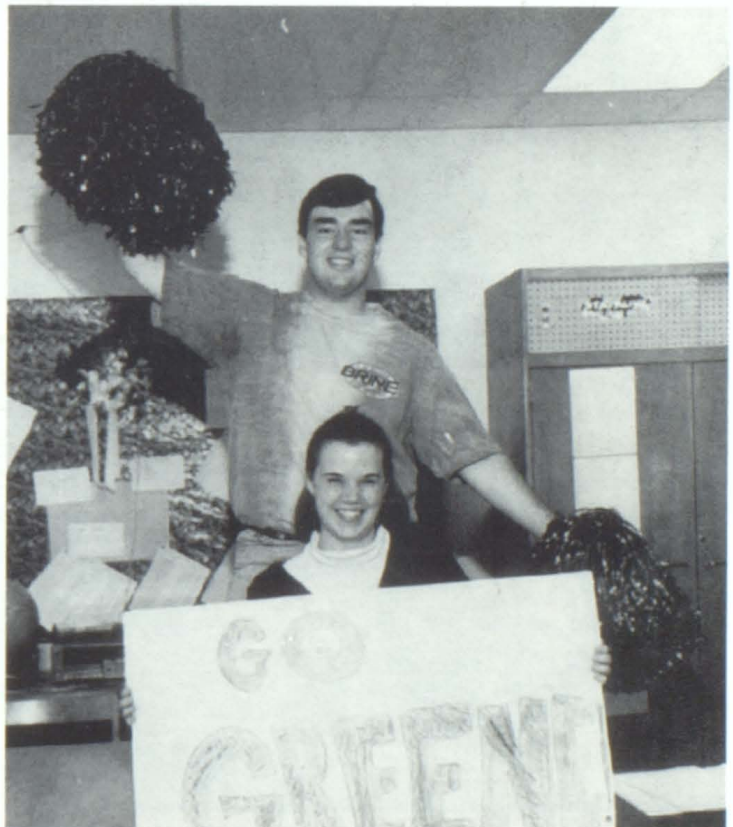

MOST INTELLIGENT
E. McCabe and D. Madara

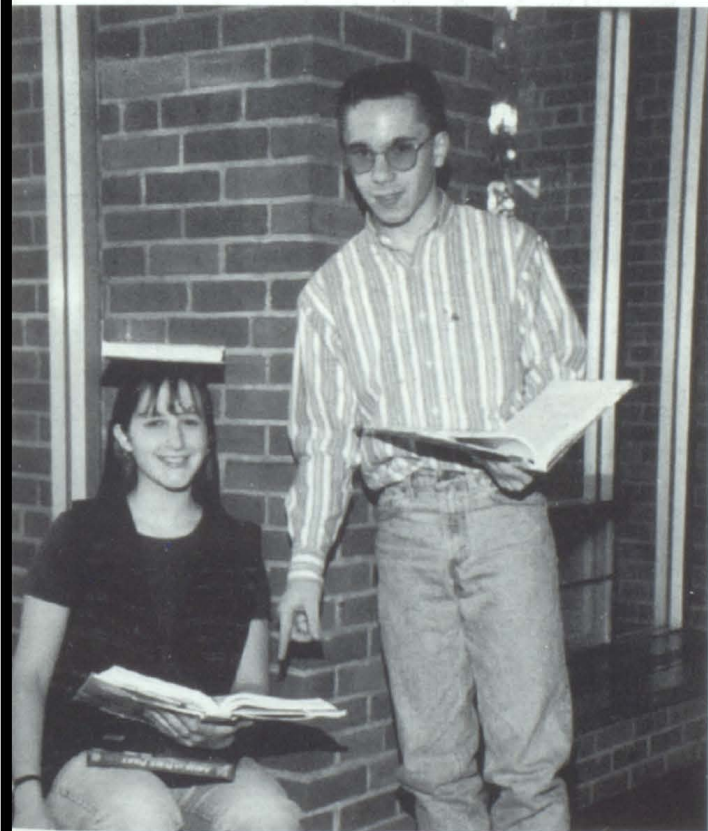

EXCHANGE STUDENTS



I'm Eduardo Paredes, I'm an exchange student from La Serena, Chile. I came in January '93 and I got stuck in NYC for one night because of a big snow storm, and then I finally got to Greene. I never thought it was going to be such a small town but I had a great time. In the spring I joined the tennis team and in the fall I joined the soccer team. I want to thank everyone who helped me when I didn't know the language well, and I want to thank Michael Wilcox, who always helped me.

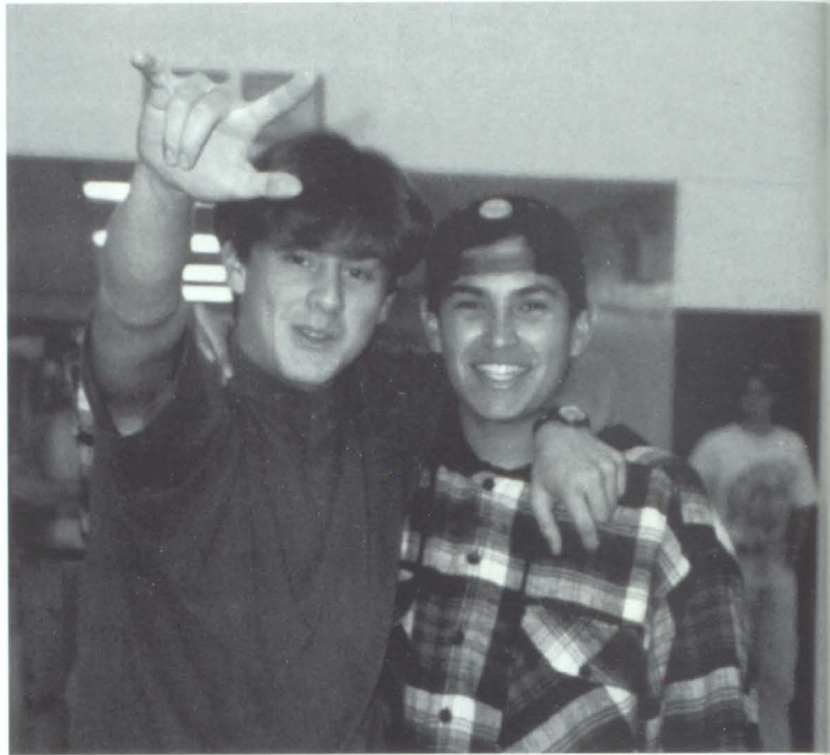

Hi! My name is Rudy Barea. I'm from Bolivia, I'm 17 years old, I'll be 18 on February 24th. I was on the Varsity Soccer team, however, my favorite sport is volleyball. I'm also in Ski Club and I have found myself to really enjoy it. I'm a Senior this year at Greene Central School. I came on August 27, 1994 and I'm leaving in August 1995. I have 2 brothers and 1 sister. My father is a doctor and my mother a lawyer. I like the way we change classes in school. I like to make music and I can also play guitar. I'm so happy for staying in Greene and I'm grateful to Mr. and Mrs. Pelkington for everything.

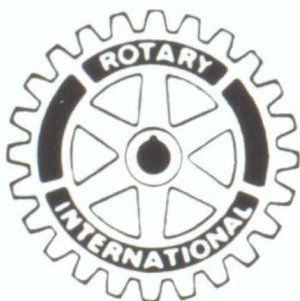



CLASS REPRESENTATIVES
Larkin, T., Schoenmaker, A. (L-R)



CLASS OFFICERS
Spicer, O., Fyfe, T., Kurz, B. (L-R)



CLASS ADVISOR
Mr. Smith

We cannot change yesterday . . .
That is quite clear.
So begin on tomorrow
Before it is here
Then what is the best for you and for me
Is to make today as complete as can be.
— Anonymous

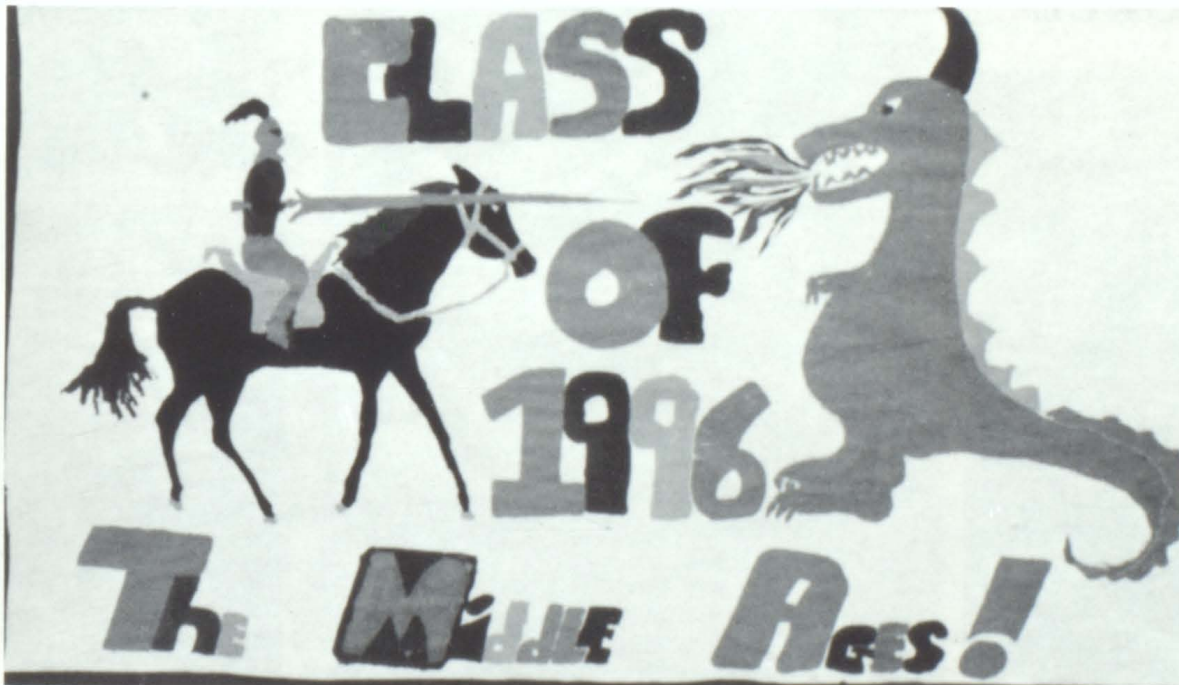

J U N I O R S

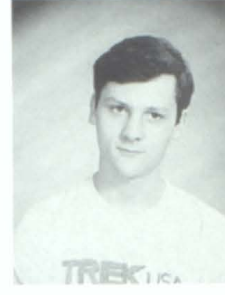

T-B Alger, K.
Bomboy, P.
Calice, P.

T-B Aukema, C.
Bonner, L.
Campbell, D.

T-B Baer, A.
Brancato, T.
Carey, J.

T-B Barden, K.
Burlison, G.
Carter, K.

T-B Beckering, T.
Burt, W.
Chakmakian, N.

T-B Begley, M.
Calice, J.
Chamberlin, L.

HOMEROOM

101

MR. FARUZEL

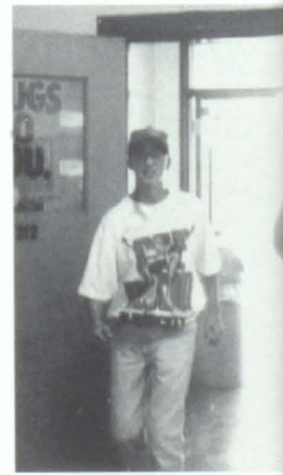
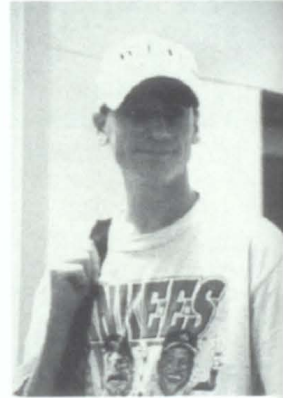

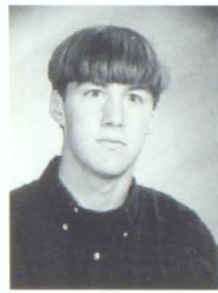

Clark, K.
Fiaschi, R.
Hall, S.

Davies, E.
Fors, A.
Hanzalik, W.

Drake, S.
Fowlston, S.
Henninge, J.

Dudra, C.
Fyfe, T.
Herrick, M.

Evans, C.
Gorman, N.
Hine, T.

Fargnoli, R.
Gross, T.
Hughes, E.

HOMEROOM 201 MR. COOK

Missing:
Colebrooke, L., Connelly, M., Corin, R., Dillenbeck, S.



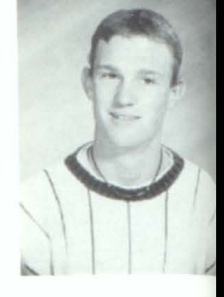
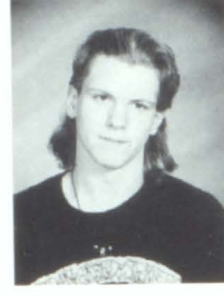
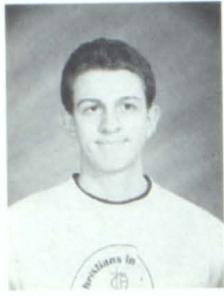

T-B Ingraham, M.
Larkin, T.
Oliver, B.

T-B Ives, K.
Lewis, S.
Ondrusek, M.

T-B Jones, A.
Marvin, C.
Paredes, E.
Pry, M.

Koerts, A.
McKeon, A.
Pessino, V.

T-B Kurz, B.
McMullen, J.
Preston, V.

T-B Lamberg, J.
Mulroy, J.
Price, M.

HOMEROOM

201

MR. BURGHARDT

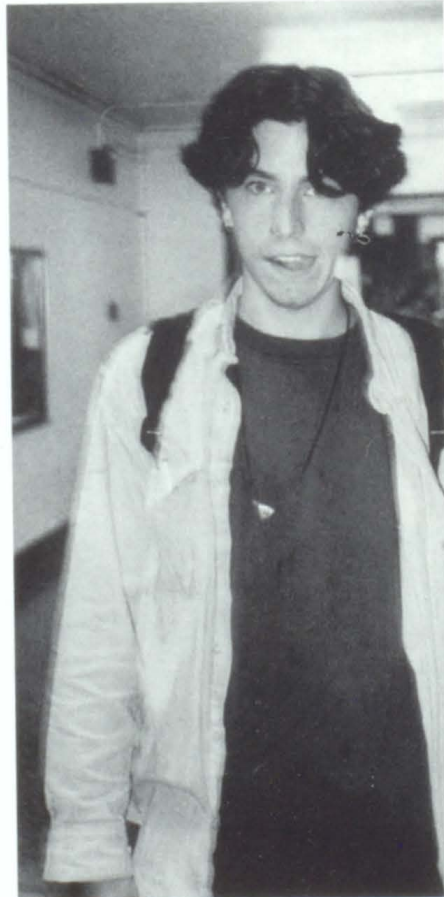



T-B Root, M.
Schoenmaker, A.

T-B Roser, B.
Schultes, A.

HOMEROOM

204

MRS. DANIELS

T-B Quick, M.
Roser, D.
Schwarz, J.

T-B Race, L.
Roser, M.
Seeley, C.

T-B Raimo, R.
Sanders, A.
Sergi, D.

T-B Reed, R.
Sawyer, M.
Shoemaker, P.



Shoemaker, R. — Missing Picture

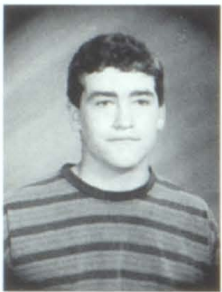
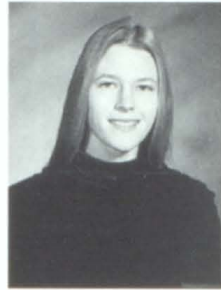
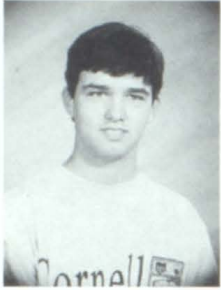
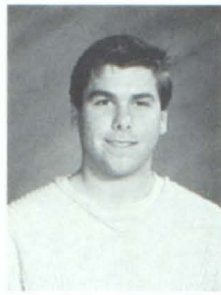

T-B Snow, M.
Ungemach, A.

T-B Sonn, D.
Walls, C.

T-B Spcier, O.
Welch, S.

T-B Sterling, S.
White, C.

T-B Simpson, D.
Taft, R.
Wilkes, M.

T-B Small, S.
Tennant, J.
Williams, M.

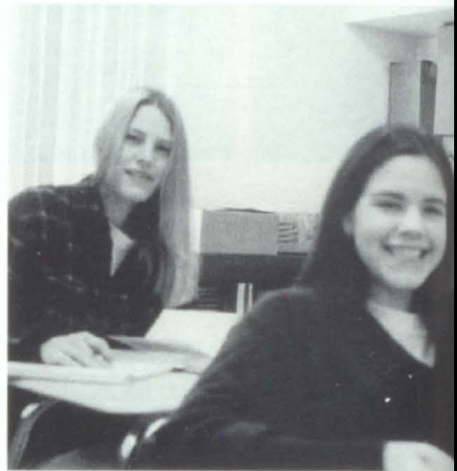

HOMEROOM

206

MR. GRANAN

Missing from picture:
Simpson, S., Walker, F., White, L., Zaleski, D.

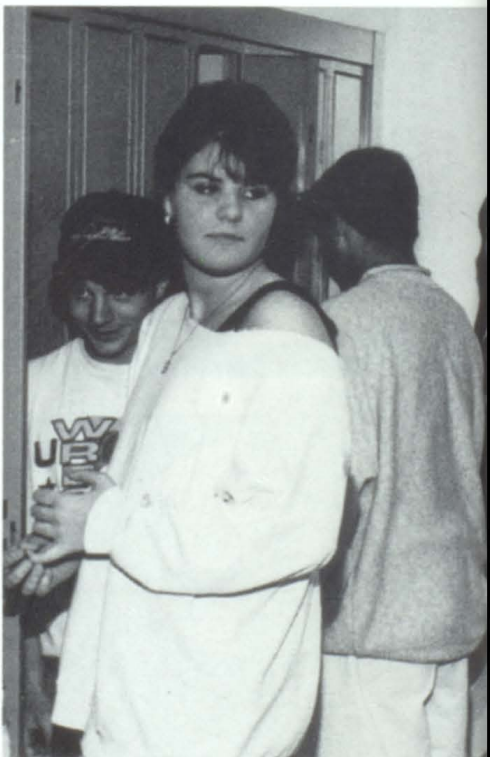

Miss Me But Let Me Go . . .

When I came to the end of the road
And the sun has set for me,
I want no rites in a gloom filled room,
Why cry for a soul set free.
Miss me a little-but not too long,
And not with your head bowed low.
Remember the love that we once shared,
Miss me-but let me go.
For this is a journey that we all must take,
And each must go alone.
It's all a part of the Master's plan,
A step on the road to home.
When you are lonely and sick of heart,
Go to the friends we know.
And bury your sorrows in doing good deeds,
Miss me-but let me go.

Kristone



ZIUVEN BILSKI

12-27-78 — 5-13-94





OUR ADVISOR

Mr. Mason



OUR OFFICERS

S. Eggleston, J. Whitbeck, M. Kofira, B. Ohl

SOPHOMORES

I still find each day too short for all the thoughts I want to think, all the walks I want to take, all the books I want to read, and all the friends I want to see.

— John Borroughs



OUR STUDENT COUNCIL REPRESENTATIVES

J. Rosser, S. Chakmakian



OUR AWARD WINNING BANNER!

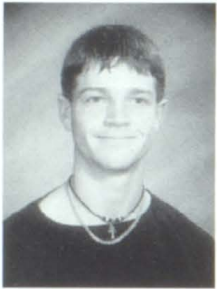

E. Archer, K. Armstrong, A. Barnes, V. Bauer, L. Beam, S. Beebe, R. Begley, A. Bennett, M. Beuth, C. Boardman, P. Bowen, N. Brennessoltz, A. Brown, D. Burkholder, E. Cannon, C. Carr, E. Case, T. Casey, P. Cazar, S. Chakmakian, N. Cline, C. Clinton

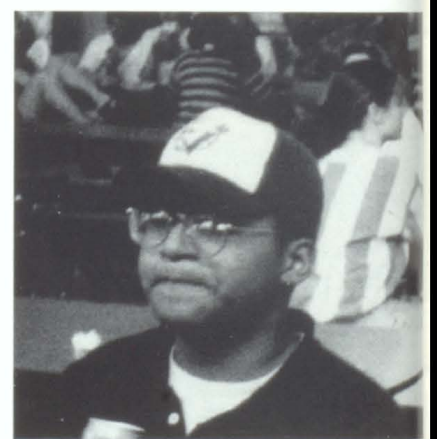

Mrs. Vizvary
Room 203



Row L-R R. Connelly, A. Crandall, A. Crumb, S. Eggleston, J. Ehlers, N. Ehlers, Row 2 S. Ellsworth, D. Evans, T. Flanagan, A. Fors, R. Fowler, C. French, Row 3 H. French, E. Garringer, J. Gincerowski, N. Glover, K. Guglielmo
Missing: B. Davis, E. Ellefsen, J. Flanagan



Mr. Case
Room 208

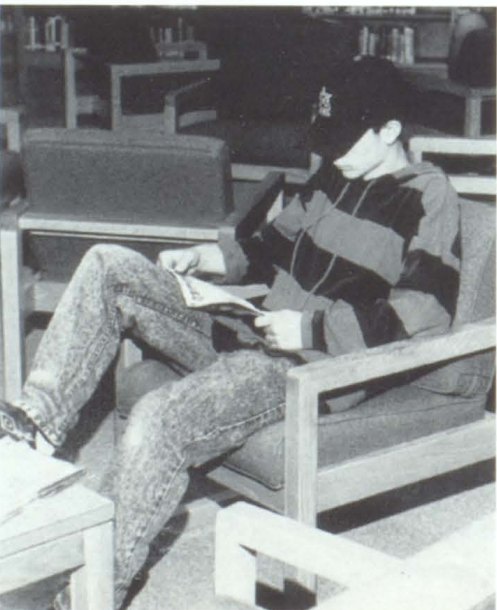
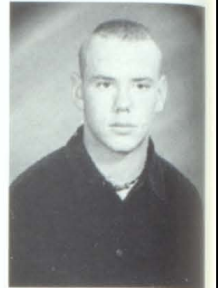

L-R K. Haines, J. Hall, J. Harbold, J. Harris, K. Hatch, M. Hickey, J. Hoteling, S. Jacquet, M. Jenks, B. Jennings, L. Johnson, C. Kilmer, K. Kinne, M. Kofira, D. Koopman, J. Krisko, J. Lamberg, J. Marvin.
Missing: R. Holdredge, J. Kelly, K. Kisner, L. Luyster

Mrs.
Woodward
Room 209

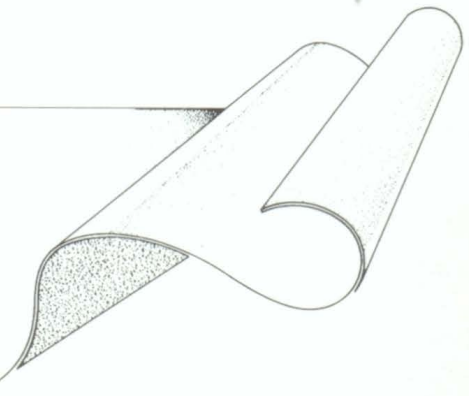

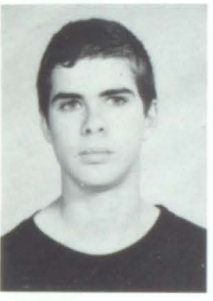
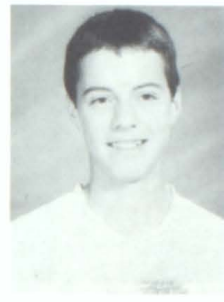
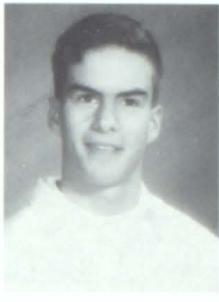
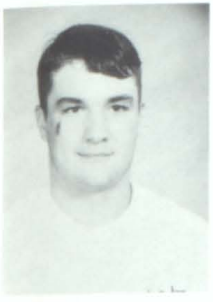

T. McCabe, F. McKeon,
 K. McLean, S. Messina,
 J. Milk, S. Mandore, M.
 Moorehead, R. Niggli,
 W. Ohl, B. Patak, A. Pos-
 semato, J. Pratt, J. Price,
 N. Puglisi, R. Rapp, A.
 Rhodes, J. Roser, J. Sack-
 ett, J. Sackett, G. Schaff,
 B. Schwarz, C. Shafer,
 M. Shaffer



Miss Martin
 Room 210

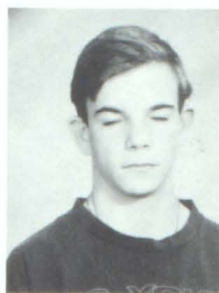
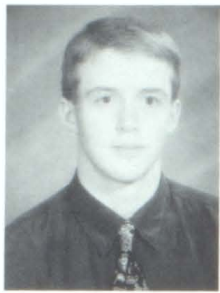

C. Shields, R. Simpson, J. Small, C. Smith, R. Smith, V. Smith, R. Starr, A. Stevens, H. Swift, D. Tab, B. Tuttle, B. Utter, K. Wallin, M. Weir, J. Whitbeck, A. White, J. Wrench, D. Young, Missing: K. Webb

Mr. Mazzitelli
Room 211

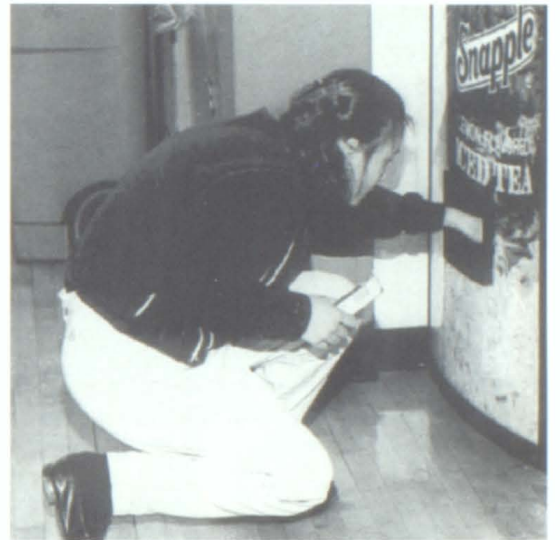
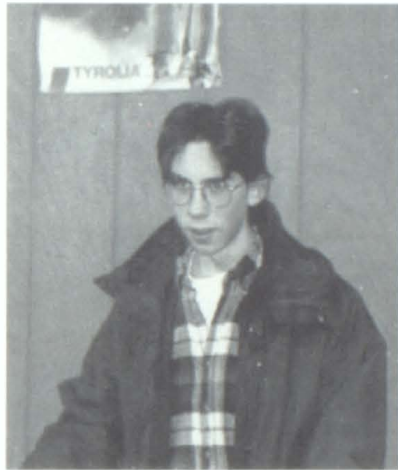
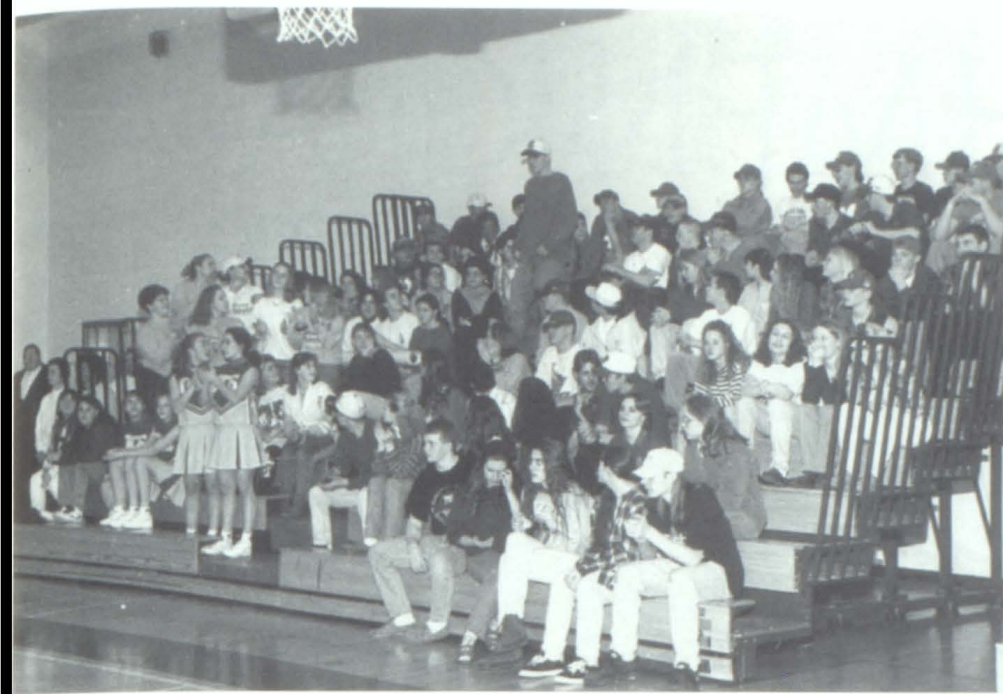

SOPHOMORE
CANDIDS

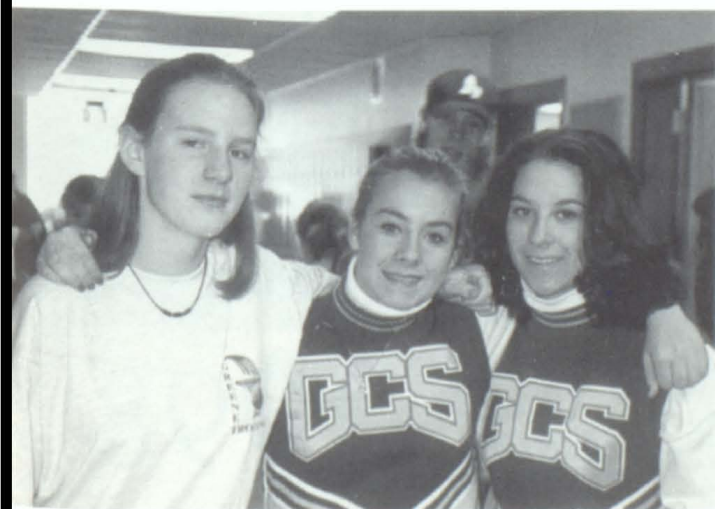

FRESHMEN CLASS



CLASS OFFICERS

Pres. M. Schoenmaker, V.P. C. Richards, Sec. R. Roser, Treas. G. Barrows



CLASS REPRESENTATIVES

T. Beach, B. Shearer

"It is a great error to take oneself for more than one is, or for less than one is worth"
— Goethe



Mrs. Riggs
ADVISOR



CLASS OF 1998



ROOM Mr.
213 HALL



Row 1: L-R, J. Bardalmas, A. Barnes, G. Barrows, T. Beach, N. Beecher, J. Boeltz, 2: T. Breck, J. Brown, C. Browning, A. Brunelle, J. Bryant, M. Bryce, 3: M. Burt, A. Campbell, B. Cannarella, 4: R. Cazsador, T. Centerwall, T. Clark, J. Collins

R-1: W. Boaz, 2 E. Button, 3 D. Callahan, 4 J. Collins





ROOM 215 MRS. PHILIPPONE



Row 1 L to R B. Dedrick
 B. Dunlap
 A. Fisher
 C. Flanagan
 K. Flanagan
 Row 2 T. Flowers
 E. Fors
 T. Fyfe
 M. Garbett
 M. Gates
 Row 3 T. Gilmore
 J. Harrington
 Row 4 S. Harrington
 V. Hauptman
 Row 5 J. Henninge
 J. Hitt
 Row 6 R. Holcomb
 N. Hoteling
 Row 7 C. Howey



Row 1 L-R J. Ives, A. Jalbert, A. James, M. Jenks, I. Jones, M. Kennedy R-2 A. Kenyon, B. Kimn, K. Kinne, T. Kirchbaum, P. Koerts, J. Kresge, R-3 M. Lawrence, M. Lewis, R-4 S. McDonald, J. McHale, R-5 B. McKeon, M. McMahon

MRS.

GOLICKI

ROOM
218



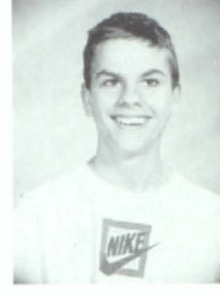

MR.
WOLCOTT

ROOM
219



Row 1 L-R S. Minihan, S. Murray, E. O'Hearn, T. Owens, N. Paden, K. Paino, 2 — W. Palmer, J. Pezzino, B. Pope, C. Richards, C. Roberts, S. Rogers, 3 — R. Roser, W. Roth, K. Ruth, 4 — B. Sage, S. Sanders, 5 — M. Schoenmaker, D. Shafer, 6 — B. Shearer, N. Simpson

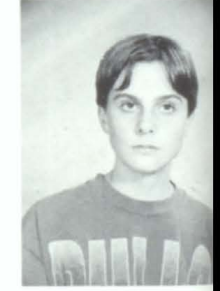

Missing Pictures:
C. Ryan, B. Small



MRS.
PETRIE

ROOM
220



Row 1 L-R K. Smith, S. Snow, J. Solomon, M. Spry, D. Stolarczyk, D. Swartwood Row 2 M. Unsell, T. Vance, M. Warnstorff, Row 3 G. Weisberg, M. Whitney, Row 4 M. Witt, A. Winters, Row 5 G. Wilkins, N. Williams, Row 6 T. Woolston, J. Wright

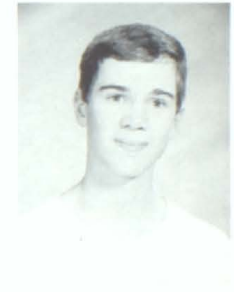

Missing: D. Webb, D. Wormuth, M. Zimmer



F
R
E
S
H
M
E
N
C
A
N
D
I
D
S

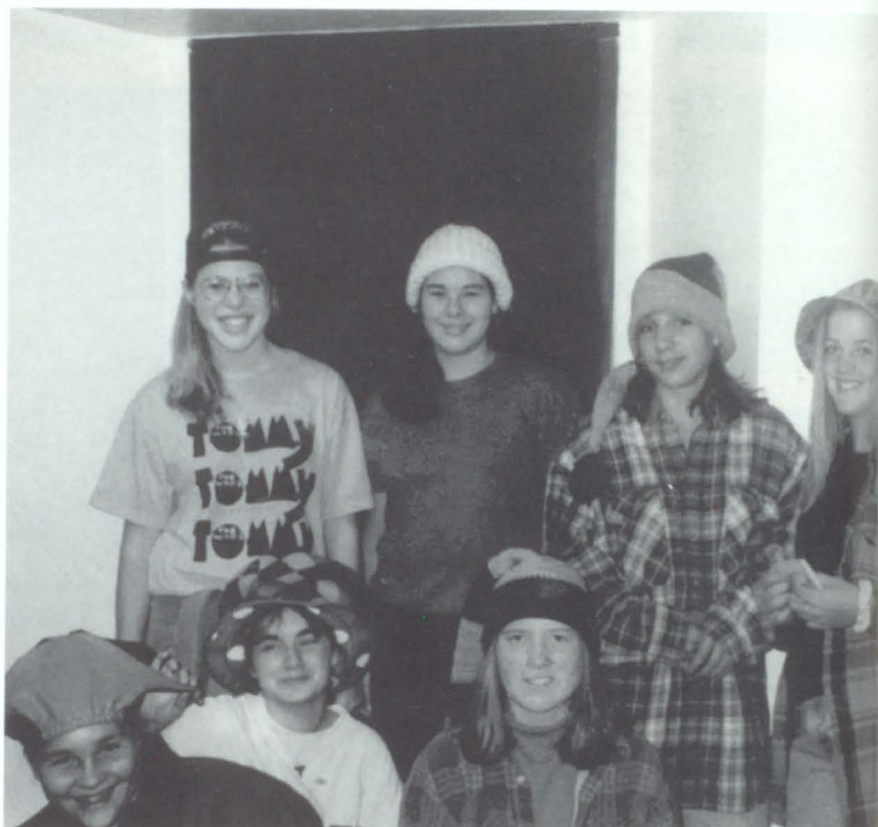

A.M.

R. Fiasch, A. Schults, S. Hall, T. Gross, T. Hine, C. Aukema, C. White, M. Snow, R. Taft, J. Tennant, F. Walker



B O O C E S

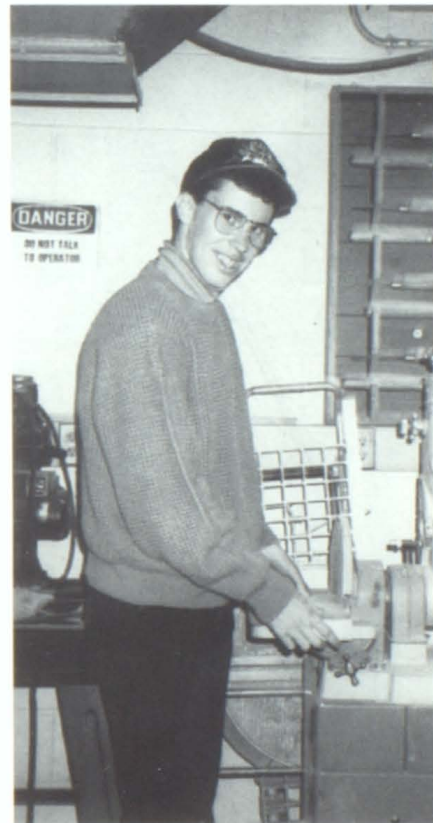

Missing:
S. Drake, C. Marvin, R. Shoemaker, D. Zaleski,
R. Reed, B. Roser, S. Small, M. Ingram, M.
Begley, W. Burt, M. Pry



P.M.

B O C E S

Row 1 S. Wheeler
Row 2 R. Root, C. Hall,
H. Button, L. Messina,
K. Badger
M. Creery
Row 3 J. Crawford, S.
Carey, W. Whitmore,
L. Valentine
Row 4 J. Tennant
Missing: M. Race



M. Race P.M. BOCES
R. Shoemaker A.M. BOCES



ALTERNATIVE SCHOOL



Pic. L-R Pic 1 B. Davis, 2 K. Pratt, 3 R. Milani, 4 R. Zollbrecht, 5 R. Zollbrecht, 6 K. Pratt



Enrollment:
Cronin, R., Davis, B.; Dillenbeck, S.; Milani, R.; Pratt, K.; Small, B.;
Zollbrecht, R.

N

nineteen ninety-five



SPORTS



R-1 T. Brown, R. Fowler, P. Calice, A. Schoenmaker, D. Driscall, R. Taft, R. Niggly, T. Eldred 2 D. Campbell, N. Chakmakian, J. Senn, T. Winston, S. Fowlston, J. Mulroy, J. McMullen, A. Pry, R. Barea, E. Paredes

V
A
R
S
I
T
Y

S
O
C
C
E
R



JUNIOR VARSITY SOCCER



Row 1 A. Campbell, B. Ohi, T. Flanagan, A. Possemato, N. Hoteling, J. Hotieing, K. McLean, T. Fyfe, Row 2 R. Cazador, J. Roser, P. Koerts, K. Hatch, J. Flanagan, K. Paino, T. Breck, R. Connelly



V. FIELD

SECTION 4 CLASS A & B STATE CHAMPS REGIONAL CHAMPS NYS CLASS B CHAMPS



H
O
C
K
E
Y

Row 1, L to R, A. Bennett, S. Chakmakin, S. Eggleston, V. Flowers, J. D'Angelo, C. Harrington, M. Frost, L. Bennett, J. Pratt, C. Jackson, Row 2, L to R D. Zeck, M. Hickey, T. Larkin, W. Cooper, K. Barden, L. Bonner, E. Case, T. Fyfe, R. Raimo, K. Carter, M. Root, G. Burlison, C. Smith



J.V. FIELD HOCKEY



Row 1 M. Hickey, K. Flanagan, J. Krisko, K. Smith, E. Browning, J. Harris, S. Murrary, C. Shafer, G. Schaff, B. Pope, R-2 H. Collier, A. Winters, T. Beach, M. Spry, B. Cannarella, A. Rhodes, M. McMahon, M. Schoenmaker, R-3 N. Cline, J. Price, M. Kennedy, M. Garbett, S. Mondore, B. Jennings, H. French



VARSITY FOOTBALL

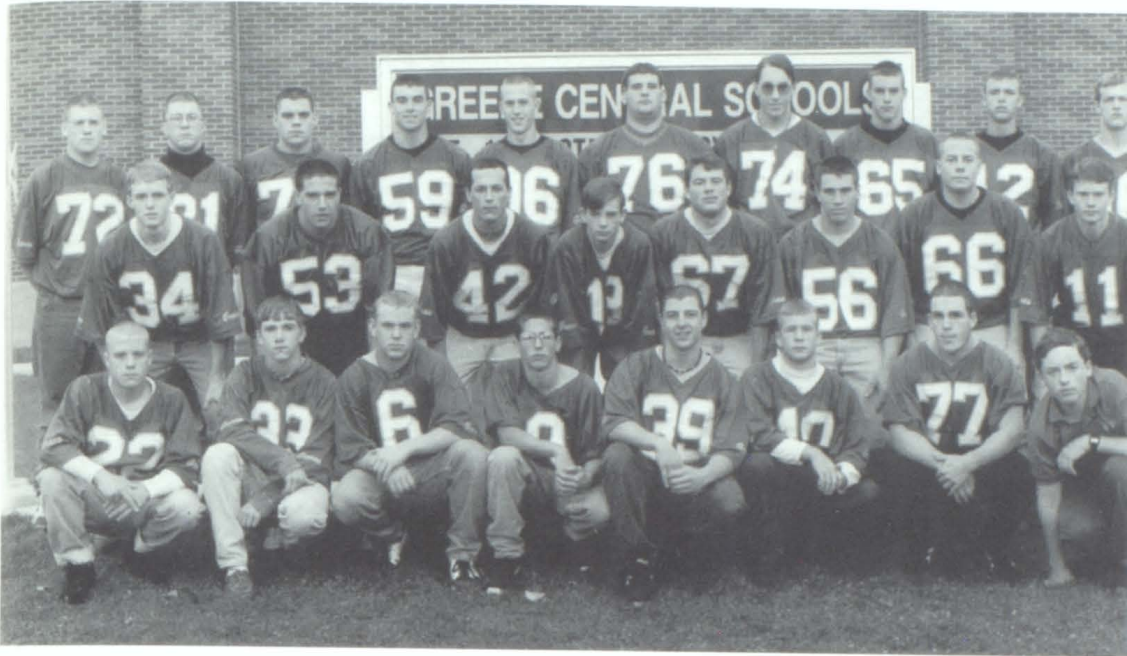

Row 1: B. Eggleston, J. Small, C. Kilmer, B. Schwartz, J. Wrench, J. Schwartz, J. Kelly, M. Beuth, Row 2: R. Simpson, J. Milk, D. Gaus, B. Smith, C. Smith, E. Garringer, J. Schoenmaker, A. Heisler, Row 3: J. Harvey, J. Hoyt, J. Amell, S. Breslin, K. Weir, B. Shevlin, M. Weir, S. Kirchbaum, N. Sergi, A. McKeon

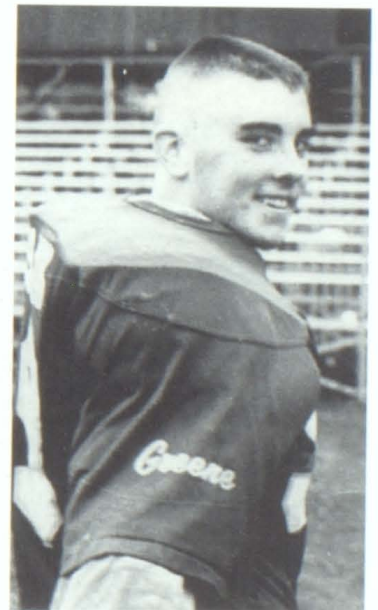

SEASON RECORD: 8-1!!

MODIFIED A TEAM

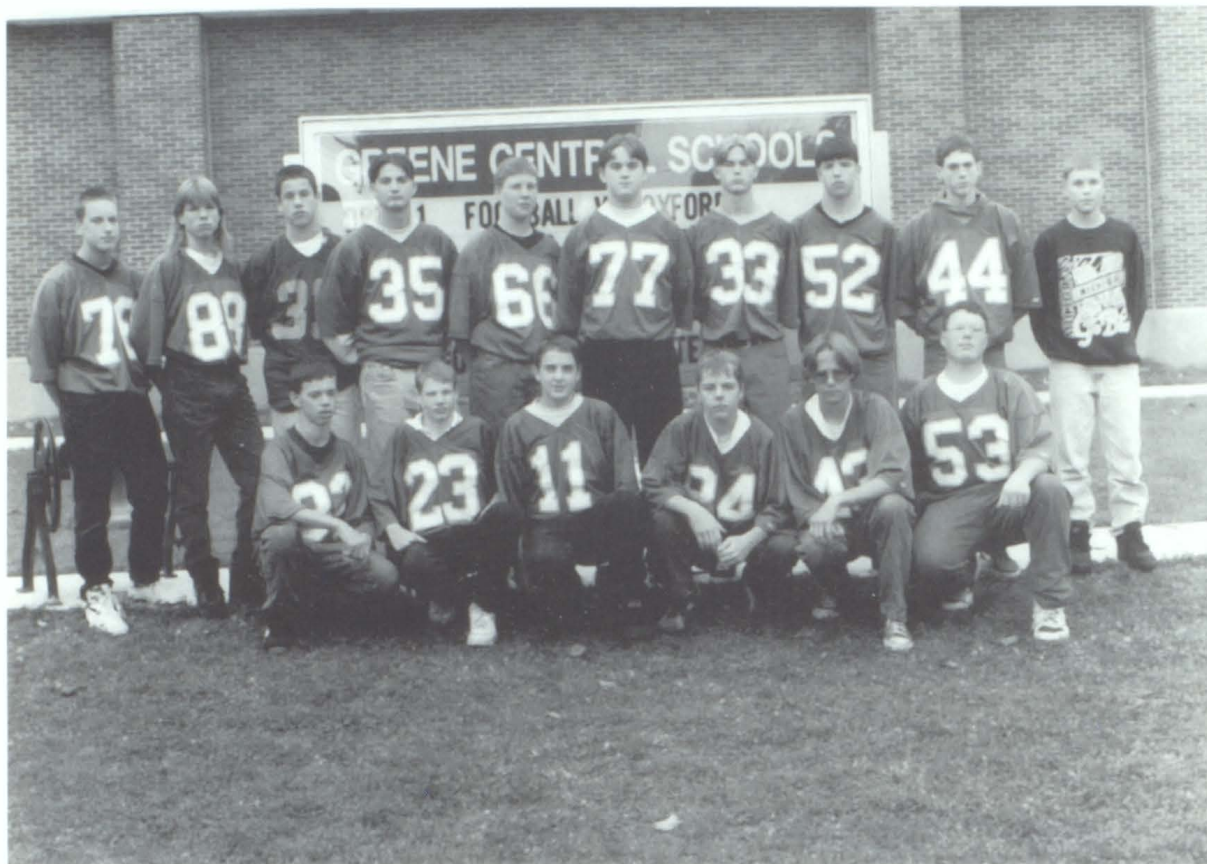

L.R.J. Harrington, C. Ryan, J. Hill, M. Whitt, S. Harrington, S. McDonald, Row 2 R. Holcomb, A. McLain, M. Lewis, T. Gilmore, G. Barrows, J. McHale, A. Brunelle, W. Ruth, T. Flowers, T. Kirchbaum



FOOTBALL CHEERLEADERS



L TO R 1, S. Carey, T. Hine, K. Wallin, C. Seeley, M. Kofira, T. Clark, M. Jenks, J. Pratt, T. Gross, T. Fey 2, A. Fisher, 3, D. Simpson





Row 1 L-R B. Winston, L. White, Fors, V. Pezzino, C. Oliphant, E. McCabe, R. Rapp, S. Tennant. Row 2 C. Spicer, A. Meister, V. Bauer, J. Carey, H. Beebe, E. McGrath, S. Welch, J. Brown, Mr. Storman



Girls' Tennis





Row 1 L. Johnson, J. Hall, B. Shearer, J. Ives, J. Whitbeck, D. Koopman. Row 2 B. Mellem, K. Fagnoli, J. Garnar, C. Centerwall, M. Whitney

C R O S S C O U N T R Y



V. BOYS' BASKETBALL



Row 1, L to R, B. Eggleston, C. Wilkes, D. Gaus, N. Chakmakian, A. Pry, T. Winston, S. Barnes, A. McKeon
 Row 2, L to R, Garnar, K. Weir, C. Centerwall, J. Mulroy, T. Short, R. Fargnoli, A. Schoenmaker



J.V. BOYS' BASKETBALL



T. Breck, B. Smith, A. Possemato, T. Flanagan, Row 2 L-R K. Hatch, J. Flanagan, F. McKeon, J. Roser, T. Gilmore

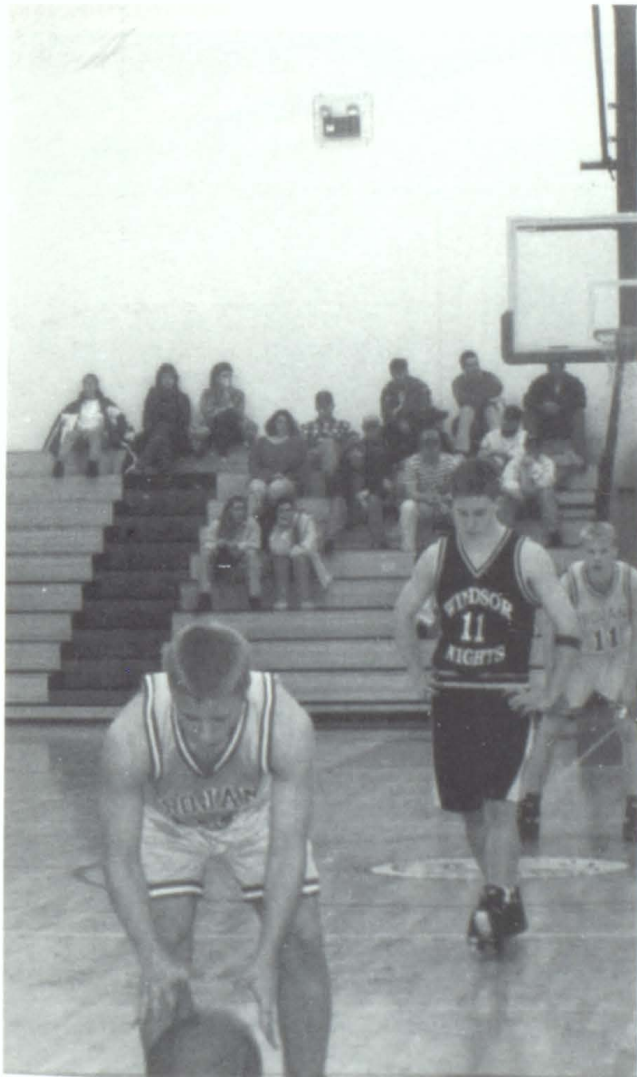

FRESHMEN BOYS' BASKETBALL



Row 1 J. Collins, B. Boaz, B. Kim, C. Roberts, Row 2 M. Bryce, M. Lewis, B. Paino, M. Burt, J. Harrington, N. Paden

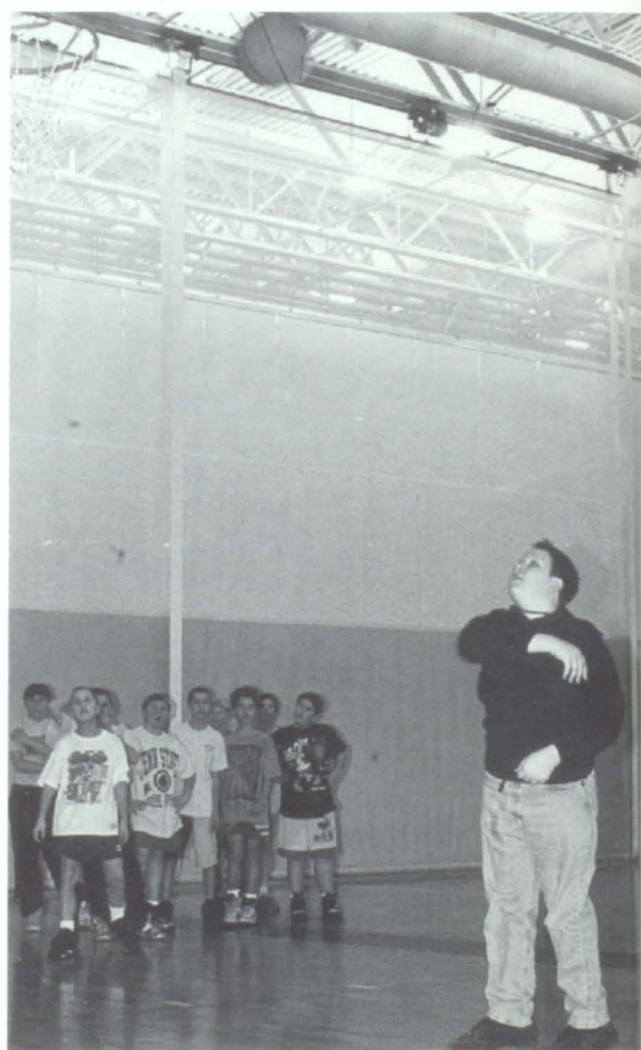

SUS. LEAGUE — WEST CHAMPS
OVERALL SUS. CHAMPS
SECTION 4 CLASS C CHAMPS



L-R row 1 E. Case, L. Bennett, K. Barden, J. Pratt, E. Case, 2 T. Larkin, J. Carey, D. Simpson, C. Cyr, L. Colebrooke

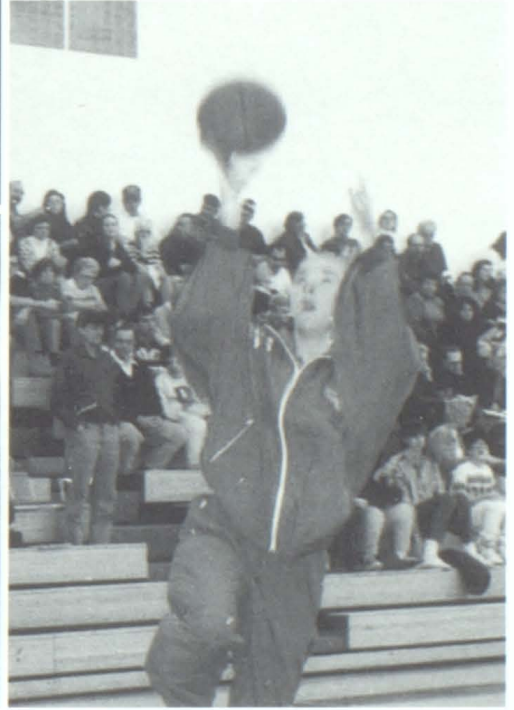

V
A
R
S
I
T
Y

G
I
R
L
S'

B
A
S
K
E
T
B
A
L
L

J.V. GIRLS' BASKETBALL



Row 1 L-R A. Meister, J. Whitbeck, K. Flanagan, B. Shearer, R-2 A. Bennett, A. Campbell, R. Roser, V. Bauer, N. Glover, B. Pope, M. Kennedy, M. Garbett





SECTION LEAGUE
CHAMPS
CLASS C CHAMPS
2ND IN LEAGUE



Row 1, M. Snow, R. Taft, R. Fowler, K. Bordwell, J. Lamberg, B. Schwarz, R-2, J. Schwarz, T. Braman, E. Christy, J. Hoyt, M. Connelly, J. Amell, C. Loomis, K. Badger, J. Lamberg

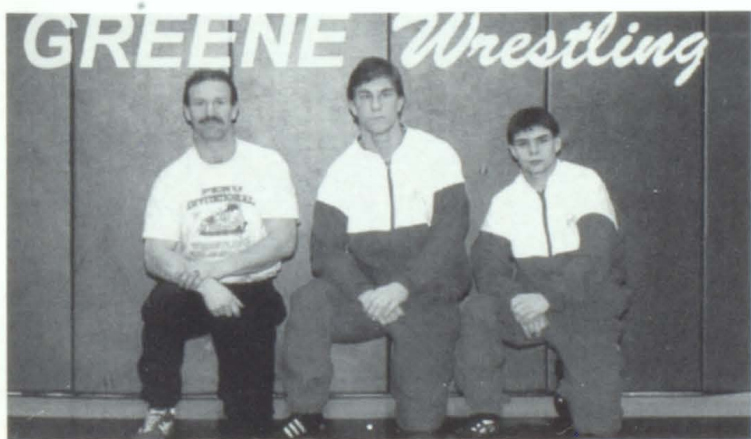
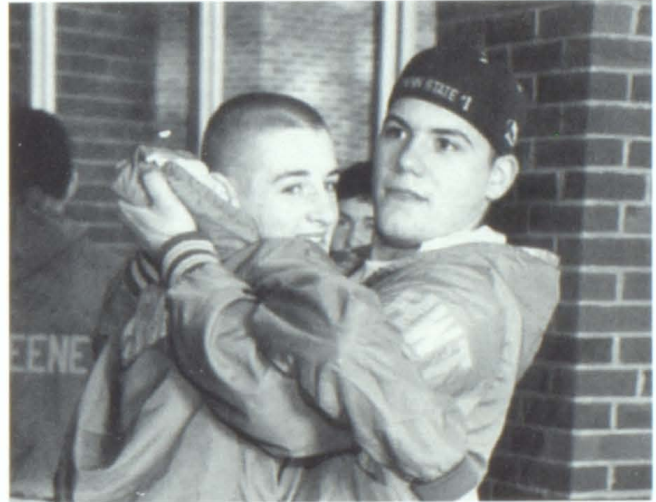

Coach Jenks, Jake Hoyt Sectional
Champ State Champ Josh
Lamberg, Sectional Champ



V
A
R
S
I
T
Y

W
R
E
S
T
L
I
N
G

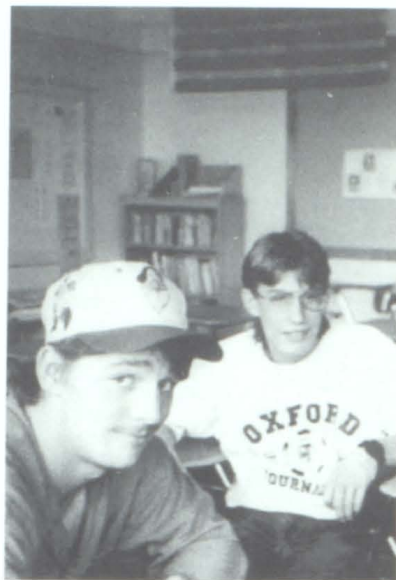
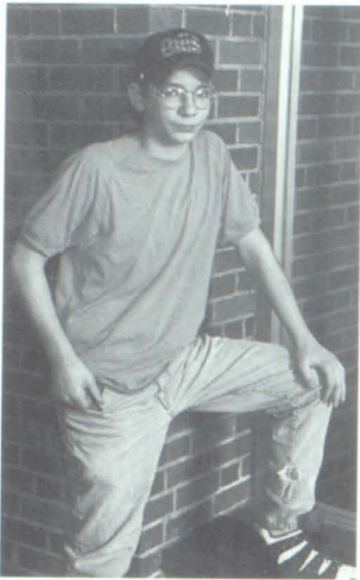

JUNIOR VARSITY WRESTLING

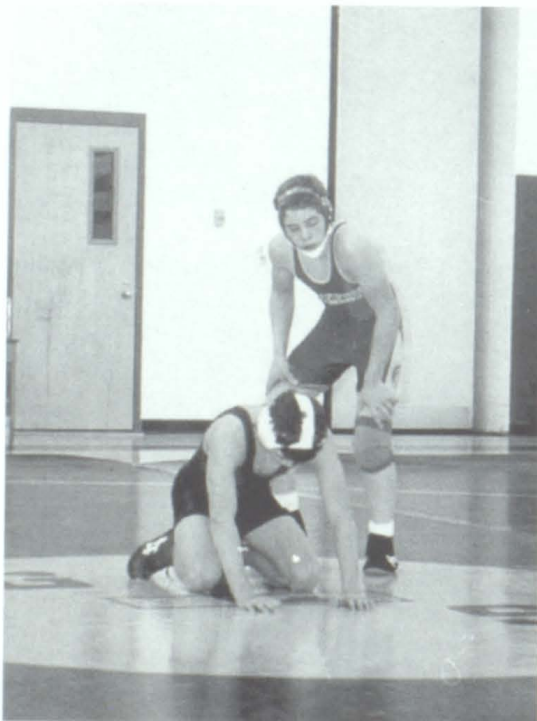

Row 1 L-R T. Flowers, G. Barrows, B.J. Roth, M. Whitt, A. Crumb, Row 2 L-R K. Badger, C. Kilmer, E. Pezzino, B. Holcomb, R. Connelly, T. Brown, J. Collins

V
A
R
S
I
T
Y

G
I
R
L
S'

V
O
L
L
E
Y
B
A
L
L



Row 1, M. Hicky, C. Jackson, J. D'Angelo, G. Burlison, B. Harris, Row 2 M. Hickey, T. Fyfe, B. Oliver, L. Bonner, K. Carter, M. Root, C. Race



J
V
G
I
R
L
S'



L-R N. Cline, B. Cannarella, K. Smith, H. French, M. Schoenmaker, K. Kinne, R. Rapp 2 M. McMahon, C. Richards, S. Mondore, T. Beach, E. Browning, Smith

V
O
L
L
E
Y
B
A
L
L

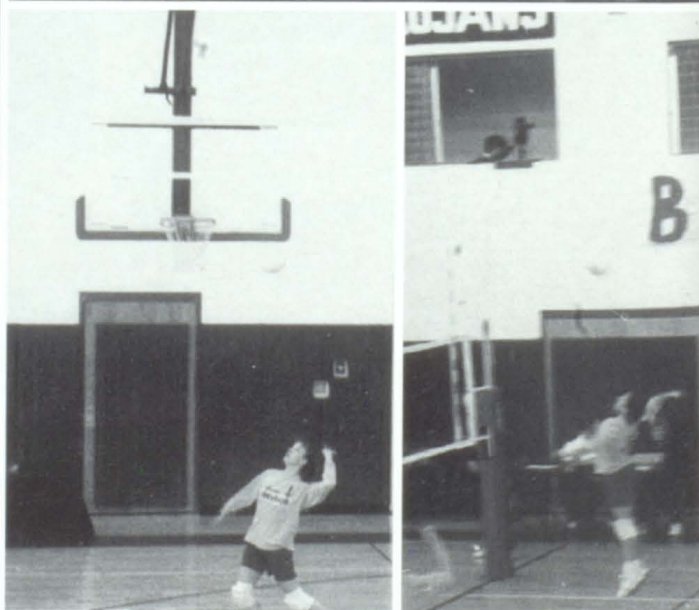

SECTION IV CLASS C RUNNERS UP RON UTTER — STATES



Row 1 L-R C. Button, C. White, J. Tennant, M. Beuth, D. Burkholder, B. Mellem Row 2 L-R D. Campbell, S. Beebe, B. Dedrick, S. Drake, K. Webb, F. Walker

B
O
Y
S'
B
O
W
L
I
N
G



GIRLS' BOWLING

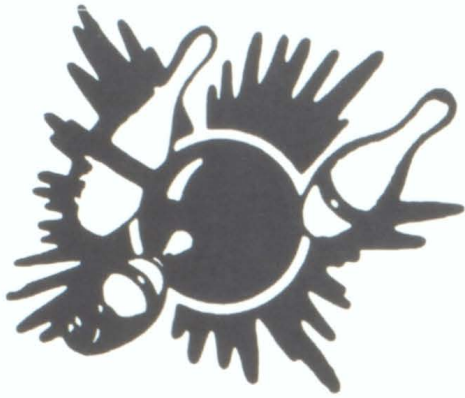

L-R 1 B. Roser, M. Roser 2 J. Calice, P. Schoemaker, J. Hall



V. G I R L S ' B A S K E T B A L L C H E E R L E A D I N G



Row 2, C. Smith, E. McGrath, S. Welch, H. Beebe, W. Cooper, S. Carey, T. Gross R-1, O. Spicer, T. Hine, R. Fiaschi, V. Flowers, M. Begley



J.V. BASKETBALL CHEERLEADERS



Row 1 L-R J. Pratt, T. Fey, A. Fisher, B. Tuttle, H. Swift 2 S. Eggleston, M. Jenks, M. Kofira, S. Chakmakian, K. Wallin, K. Ruth, T. Clark



BOYS' VOLLEYBALL



Row 1 l-r
J. Webb
B. Kaufman
C. Evans
D. Campbell
Row 2
R. Hopke
M. Bryant
D. Winters
J. Harbold

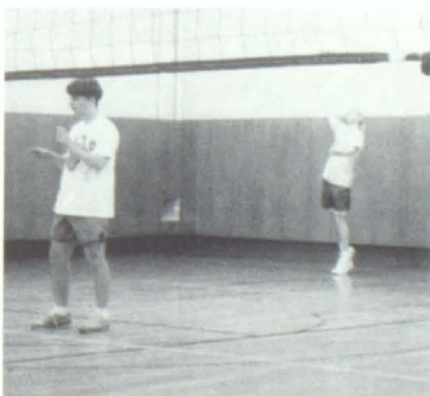
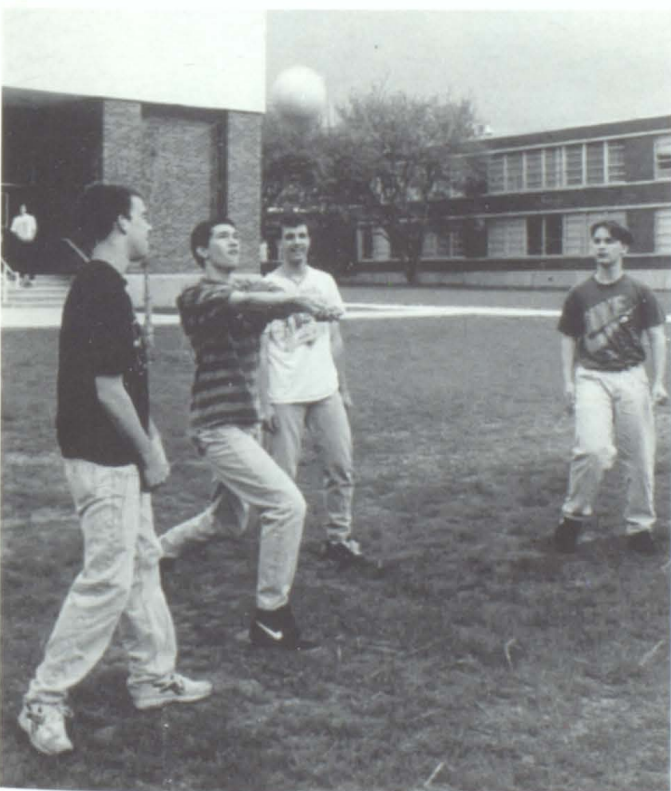

VARSITY SOFTBALL



R-1 B. Harris
 K. Clickner
 J. Pratt
 H. Koopman
 R. Utter
 R-2 D. Zeck
 M. Hickey
 E. Pooler
 C. Jackson
 L. Mikalsen
 T. Larkin
 K. Shevlin



JV SOFTBALL



Row 1 O. Spicer, V. Pezzino, S. Eggleston, M. Hickey, S. Chamakin, A. Roades, G. Shaft, A. Bennett, Row 2 Mr. G. Daniels, B. Oliver, V. Bower, J. Pratt, K. Carter, R. Raimo, S. Mondore, B. Jennings

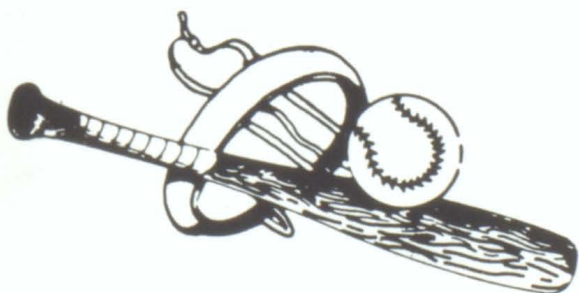

V. BASEBALL



Row 1 L-R B. Eggleston, M. Sawyer, A. Kalicicki, J. Craver, R. Utter Row 2 R. Micha, S. Youngs, J. Bobeir, N. Sergi, J. Garnar, J. Mulroy, J. Raimo, M. Hunt, D. Gaus



JV BASEBALL



R-1 J. Schwarz, B. Utter, T. Flanagan, A. Possemato, B. Schwarz, B. Smith
R-2 T. Brown, M. Quick, C. White, D. Roser, M. McKeeon, J. Stevens, S. Fowlston, C. Walls

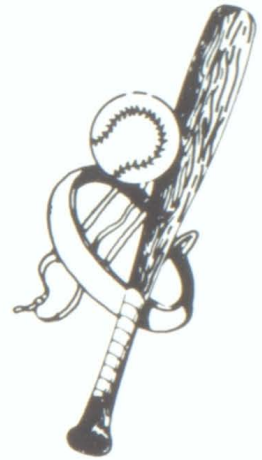

V A R S I T Y

T R A C K



Row 1 V. Flowers, J. D'Angelo, R. Fishia, K. Wallace, M. Kofira, M. Root, D. Koopman 2 R. Kaufman, E. Heisler, C. Kristie, T. Flowers, J. Hall, T. Fyfe, A. Bear, J. Carry, K. Barden, L. Bonner, E. Case





Row 1 J. Barton, P. Calice. Row 2 N. Chakmakian, B. Shevlin, A. Kofira, J. Schoenmaker, C. Woolston, M. Ingraham.



V
A
R
S
I
T
Y

G
O
L
F

BOYS' TENNIS



Row 1 L-R J. Storman, D. Winters, J. Roser, J. McMullen, J. R. Sonn, A. Pry, M. Herrick, K. Hatch, S. McMullen Missing: D. Burkholder, C. Centerwall, M. Williams, E. Paredes, T. McCabe

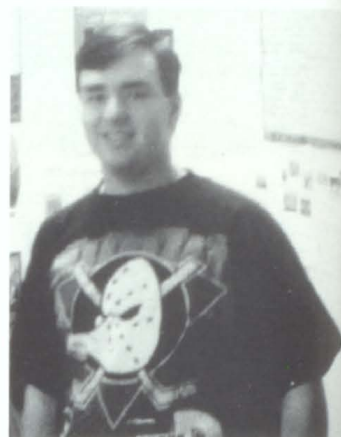

N

nineteen ninety-five

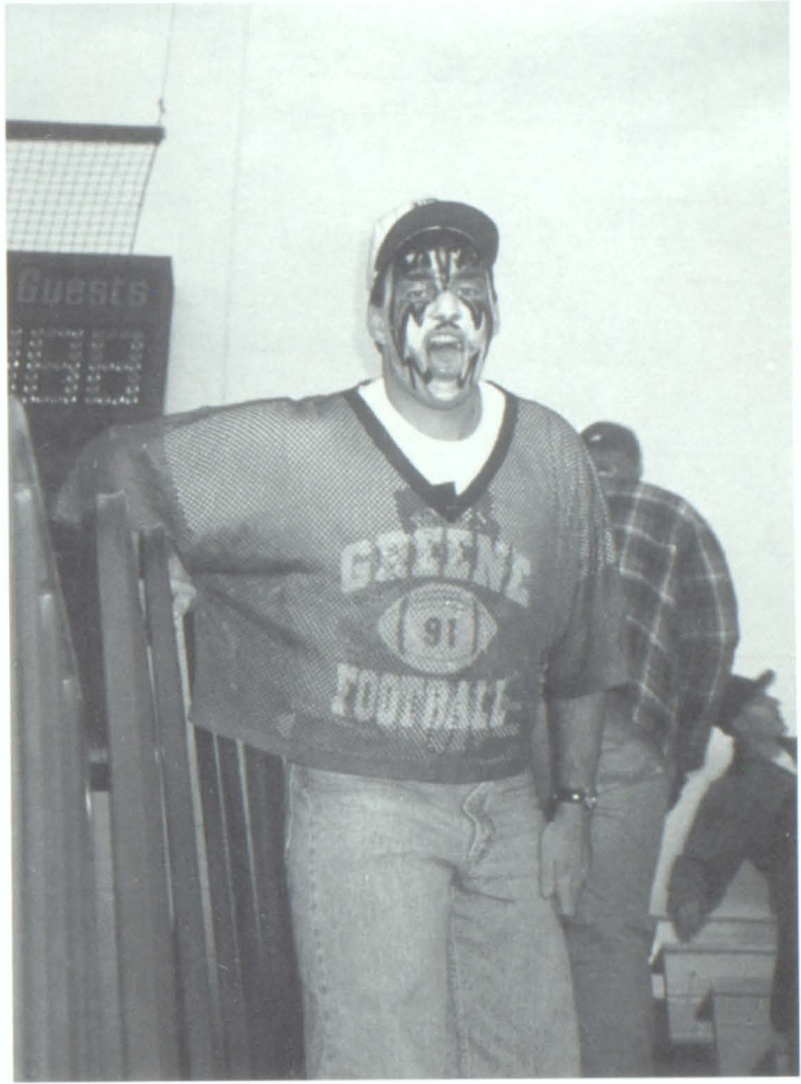

ACTIVITIES &
CLUBS

STUDENT COUNCIL



Row 1 L-R D. Richter, M. Hickey, C. Jackson, S. Eggleston, J. Krisko, C. Smith, Row 2 M. Williams, D. Burkholder, S. Breslin, L. Bennett, E. Case, L. Bonner, C. Richards, D. Swartwood, Row 3 A. Schoenmaker, B. Smith, T. Fyfe, M. Kennedy, P. Shoemaker, A. Brunelle, M. Garbett, Row 4 A. Kalicicki, B. Eggleston, A. Heisler, A. Pry

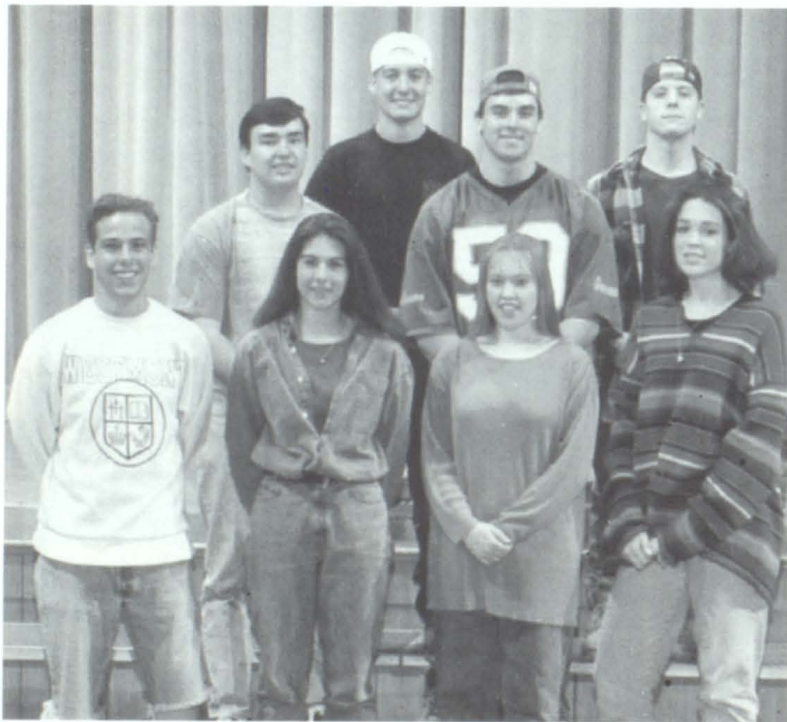
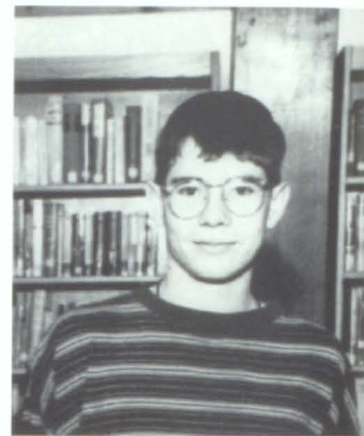

OFFICERS



HOMECOMING



Meghan Root



Livia Bennett & Ben Eggleston



Leslie Beam









JUNIOR PRINCESS
EMILY CASE



JUNIOR KING AND QUEEN
RILEY SALYARDS AND TODD SHORT



JUNIOR PRINCE
BEN EGGLESTON



SOPHOMORE PRINCESS
CORI THIBODEAU



SENIOR PRINCESS
BECKY UTTER

PROM 1994 WONDERFUL TONIGHT



THE COURT





MOVING UP DAY



SKI CLUB



L-R Row 1 Ungemach, A., Simpson, R., Sonn, J.R., Evans, C., Price, M., Dudra, C., Row 2 Cazador, R., Fyfe, T., Brunell, A., Kirchbaum, T., Krisko, J., Raimo, R., Brancato, T., Richter, D., Price, J., Youngs, J., Row 3 Pry, A., Kalicicki, A., Eggleston, B., Bennett, L., Case, E., Williams, M., Row 4 Setgi, N., Heisler, A.

GREEK

PEAK



Row 1 L-R D. Madara, L. Bonner, S. Breslin, E. Hughes, S. Lewis. Row 2 J. Schoenmaker, D. Burkholder, T. Fyfe, M. Williams. Row 3 S. Welsh, A. Schoenmaker, T. Eldred, A. Heisler, E. Davies, M. Herrick, D. Campbell

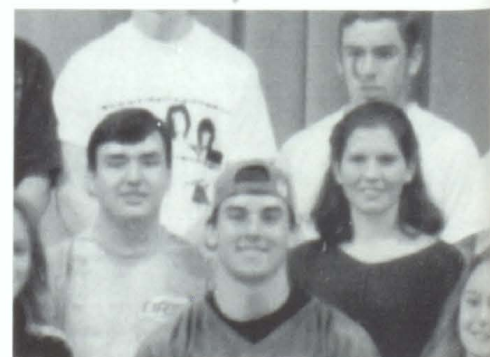

S.A.D.D.



Front Row J. Pratt, M. Jenks, Back Row S. Welch

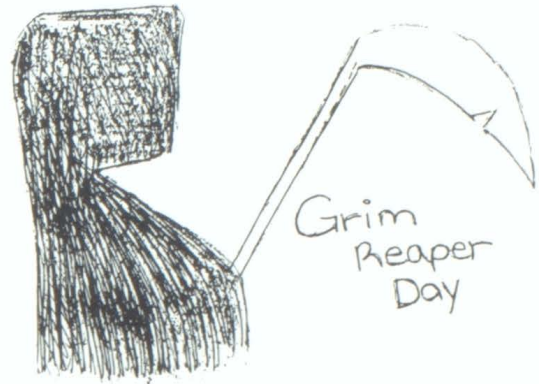

CONTRACT FOR LIFE

A Contract for Life
Between Parent and Teenager

Under this contract, we understand S.A.D.D. encourages all youth to adopt a no use policy and obey the laws of their state with regards to alcohol and illicit drugs.

Teenager I agree to call you for advice and/or transportation at any hour from any place if I am ever faced with a situation where a driver has been drinking or using illicit drugs. I have discussed with you and fully understand your attitude toward any involvement with underage drinking or the use of illegal drugs.

Signature _____

Parent I agree to come and get you at any hour, any place, no questions asked and no argument at that time, or I will pay for a taxi to bring you home safely. I expect we would discuss this at a later time.

I agree to seek safe, sober transportation home if I am ever in a situation where I have had too much to drink or a friend who is driving me has had too much to drink.

Signature _____

Date _____



Distributed by S.A.D.D., "Students Against Driving Drunk"



SPONSOR

This is to certify that

_____ is an official sponsor of Students Against Driving Drunk

_____ Chapter

and is gratefully recognized this _____ day of _____

By the S.A.D.D. Board of Directors and Chapter Participants.

Robert Anastos
Founder, Executive Director
S.A.D.D.
Marlboro, MA

_____ Principal

_____ School



Row 2 D. Madara, T. Fyfe, E. Davis, S. Lewis, B. McKeon, Mrs. Golicki Row 1 D. Richter



GIRLS' LEADERS



Row 1 L-R W. Cooper, C. Harrington, M. Frost, 2 C. Jackson, C. Smith, M. Hickey, S. Eggleston, S. Chakmakian, J. Krisko, K. Flanagan, K. Smith, B. Cannarella 3 J. Pratt, V. Flowers, J. Carey, K. Carter, M. Hickey, H. French, S. Mondore, M. Schoenmaker, 4 N. Cline, O. Spicer, T. Fyfe, M. Root, M. McMahon, T. Beach, 5 A. Bennett, E. Case, L. Bennett, E. Case, L. Bonner, V. Bauer, S. Welch, R. Raimo 6 J. D'Angelo, T. Larkin

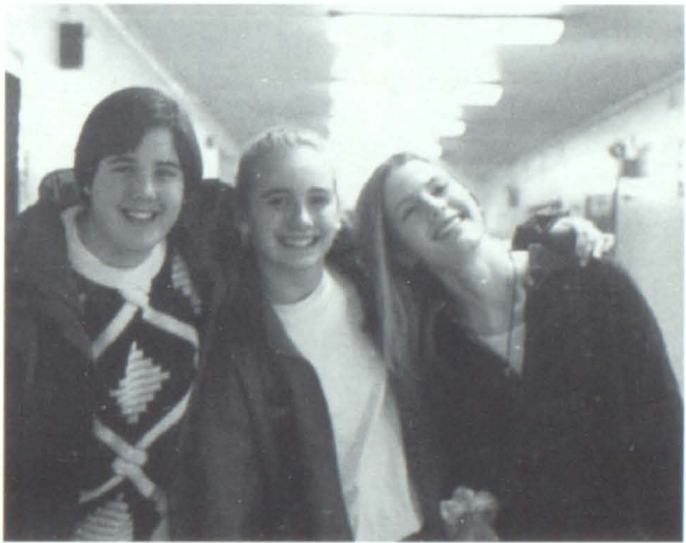

CLUB



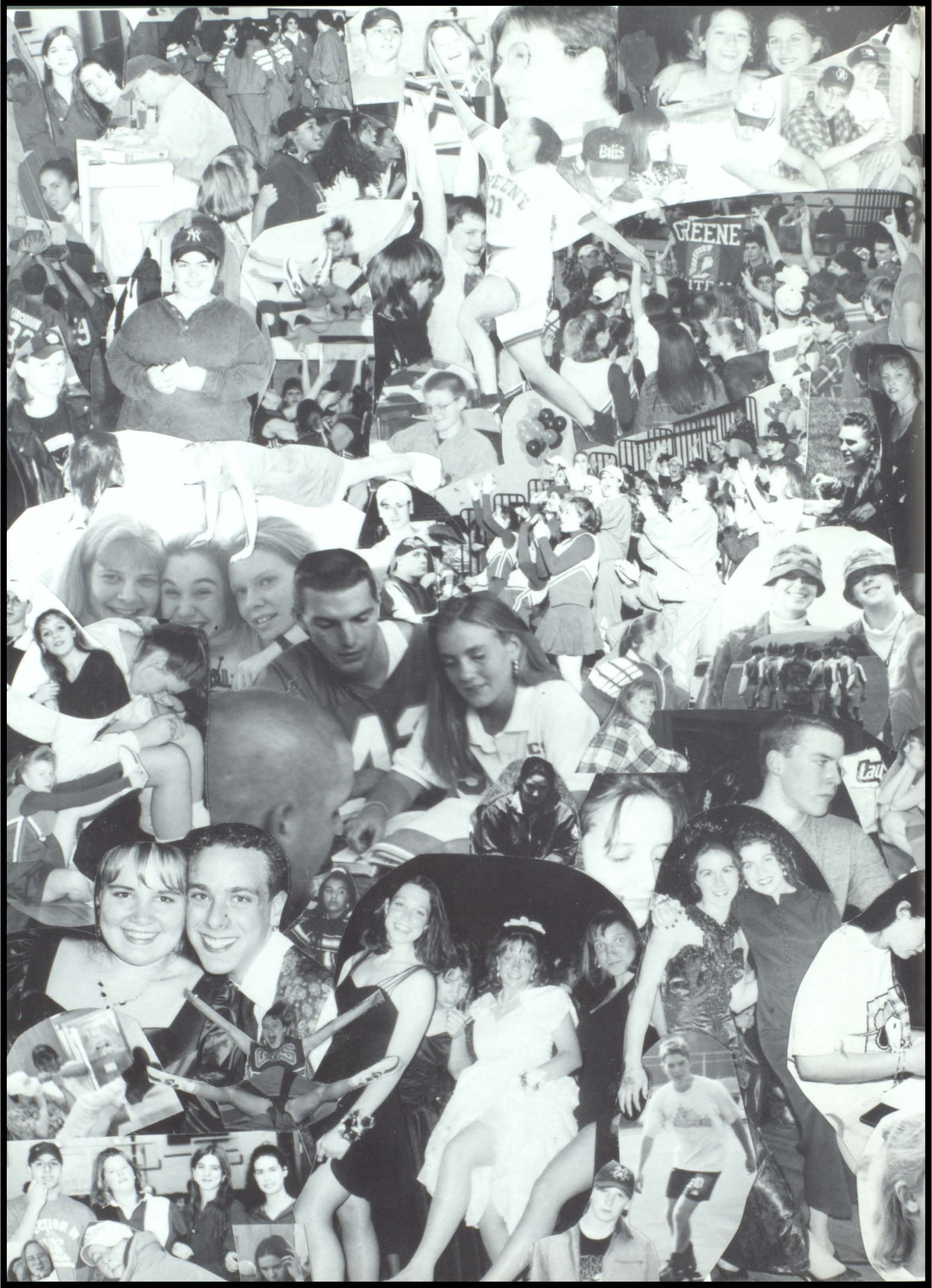

HIRING TEMPORARIES?

HERE IS WHAT EVERGREEN TEMP SERVICE CAN DO FOR YOU!!!

We can send you a skilled, qualified temp within an hour! We're just a phone call away! We'll make it worth your call. WE CAN MAKE A WORLD OF DIFFERENCE! Just to name a few areas in which we can help:

CLERICAL

•Secretaries •Word Processors
•Accounting •Receptionists

INDUSTRIAL

•Assemblers •Machinists
•Laborers •Drivers

Tired of paying Workers Comp and NYS Unemployment? We are a full Payroll Service covering all insurances and mandatory taxes.

EVERGREEN TEMPORARIES

786-2400/656-9151

October GGCC Business of the Month Award



Najarian Chiropractic

Congratulations —
Class of 1995

Dr. & Mrs. Najarian & Staff



656-4485

DR. MICHAEL J. LANGE
DR. CHRIS J. VIGLUCCI

Optometrists

Medical Arts Building
29 North Chenango Street
Greene, NY 13778

Featuring: fashion frames, contact lenses, including fashion colors that change your eye color, Serengeti sunglasses, high index lenses for glasses and much more.



Office hours by appointment

ROUNDS FUEL SERVICE, INC.

Oil Heat Specialists
37 Genesee St.
Greene, NY 13778

(607) 656-8611

Our Best Wishes
to the
Class of
1995

VARSITY CLUB



D. Gaus, B. Eggleston, K. Weir





L-R Row 1 A. Fors, J. Price, A. White, C. Dudra, B. Brown, C. Carter, J. Pratt Row 2 M. Kofira, V. Bauer, S. Welch, M. Price, D. Young, T. McCabe Row 3 D. Burkholder, O. Spicer, D. Richter, M. Williams, V. Smith



KEY CLUB

Secretary — Olivia Spicer
 President — Denny Burkholder
 Vice-President — Matt Williams
 Treasurer — Vanessa Smith



EXECUTIVE COMMITTEE

C. Carter, Editor, D. Burkholder, Manager, N. Williams R. Raimo, Editor

YEARBOOK

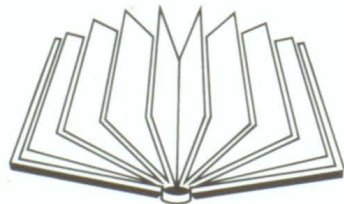

L-R Row 1 G. Wilkins, J. Wright, C. Carr, C. Dudra, K. Gugliemi, E. Fors 2 J. Krisko, B. Brown, C. Carter, D. Brkholder, M. Price, Welch, V. Bauer, D. Richter 3 R. Raimo, L. Bonner, M. William T. Fyfe, A. White Missing S. VanGieson, T. McCabe, J. Whitbed E. Cannon, S. Holcomb, T. Gross, M. Kofira, K. Wallin, J. Pratt, Roser, E. McCabe, K. Carter, A. Jones, K. Haines, K. Haines, Henninge, K. Clark, T. Hine, C. Seeley



L-R Row 1 A. Ungemach, V. Pezzino 2 D. Swartwood, S. Chakmakian, M. Kofira, V. Bauer 3 J. Pratt, J. Price, N. Cline, J. Bardalamos 4 M. Williams, D. Richter, D. Madara, B. McKeeon 5 D. Burkholder, K. Weir, T. Short, D. Gaus, D. Campbell 6 N. Sergi, A. Kalcicki, B. Eggleston

F O O T L I G H T S

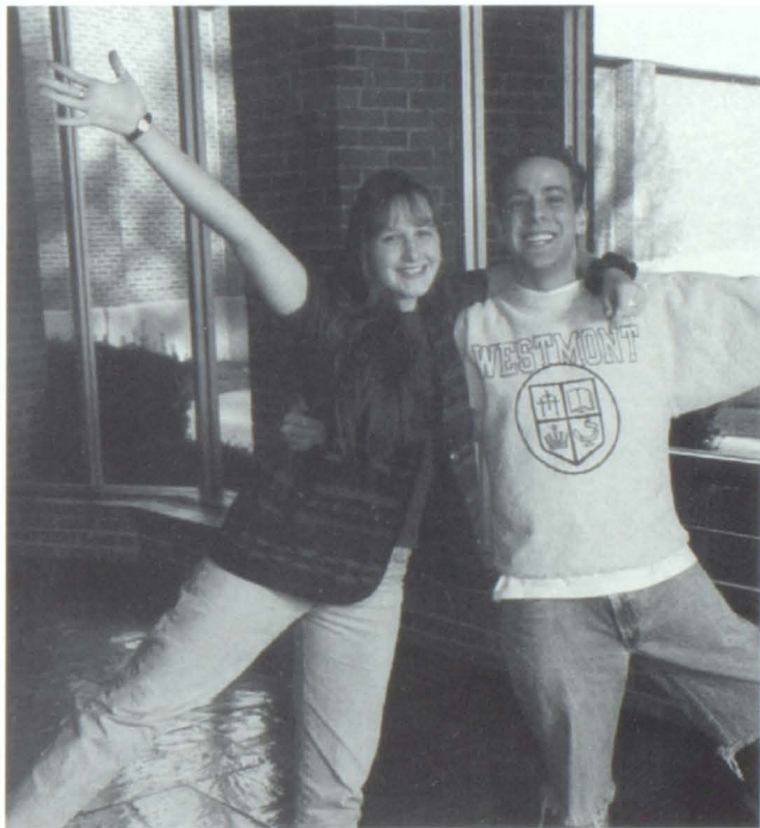

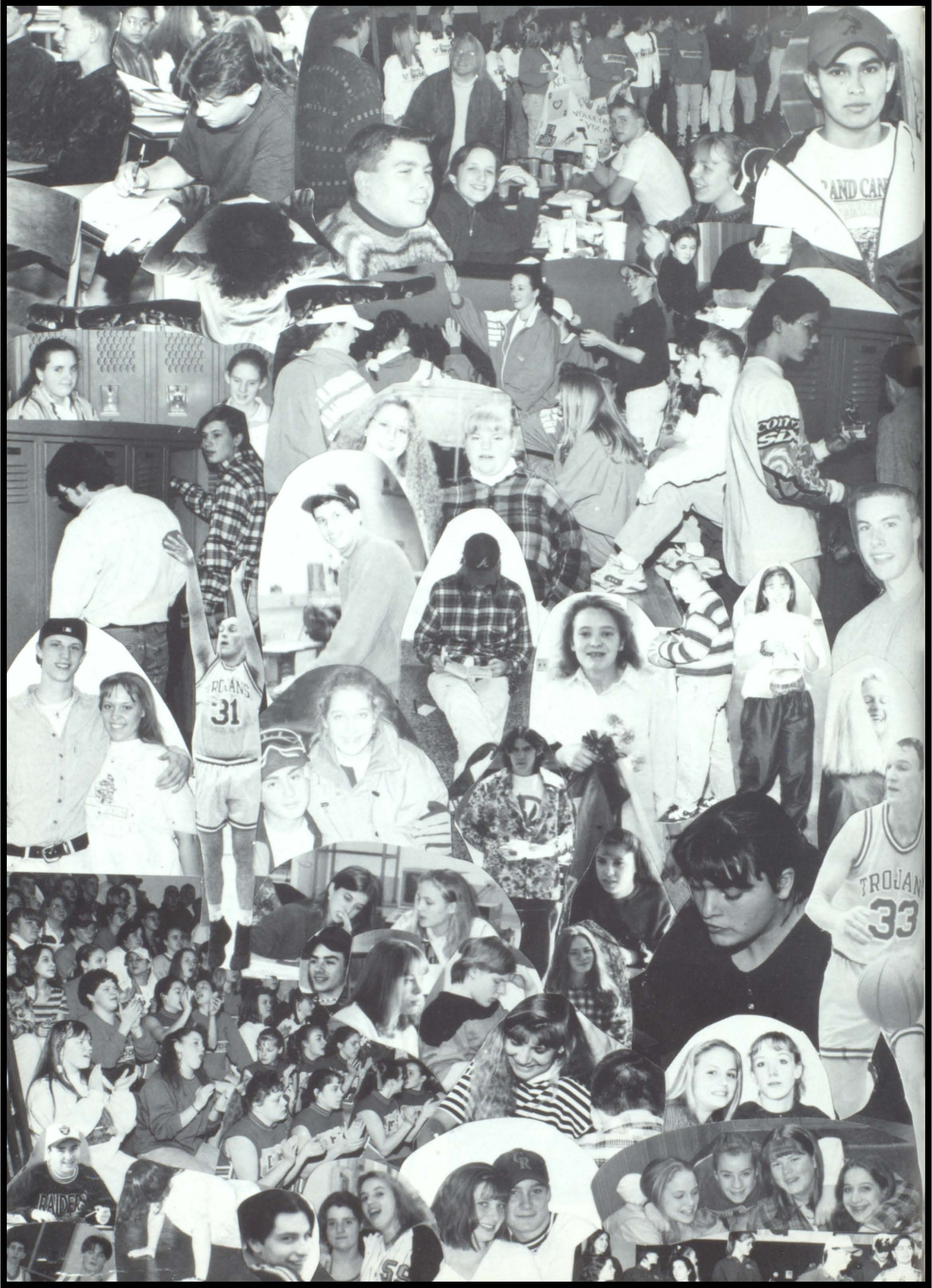

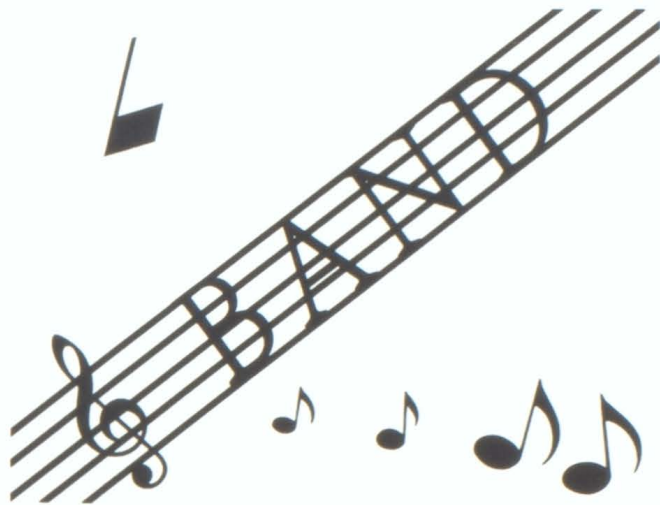

Row 1 V. Smith, J. Pratt, D. Callahan, E. Hughes, B. Kurz, V. Pessina Row 2 S. Welch, T. Owens, J. Krisko, B. Shearer, K. Barden, D. Madara, Mr. Rohrbach Row 3 M. Williams, D. Richterm, J. Bardalamas, A. Campbell, G. Barrows, B. McKeon, M. Price, V. Bauer Row 4 B. Mellem, D. Campbell, J. Garnar, T. Short, K. Weir, T. Beckering, T. Fyfe, N. Cline, M. Herrick

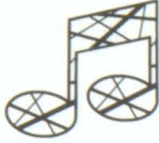

MARCHING BAND

Row 1: B. Mellem, M. Williams, K. Weir, T. Short, N. Cline, M. Kelly Row 2: D. Campbell, J. Garnar, G. Barrows, A. Campbell, K. Barton, J. Krisco, B. Shearer Row 3: D. Madara, S. Welch, V. Bauer, M. Price, V. Pezzino Row 4: B. McKeon, J. Pratt, V. Smith

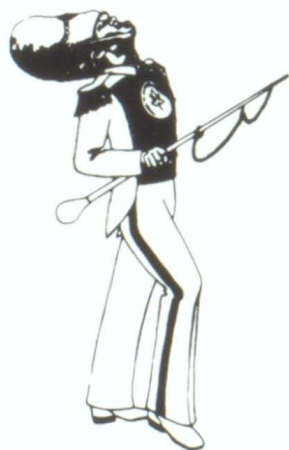



Clark, M. Kofira, J. Kresge, A. Fisher, T. Hine, J. Webster, A. Jones, D. Swartwood



C
O
L
O
R

G
U
A
R
D

SENIOR CHORUS



L-R Row 1 K. Smith, C. Smith, W. Cooper, S. Eggleston, K. Ruth, M. Schoenmaker, E. Fors 2 K. Flanagan, A. James, A. Fors, J. Sackett, J. Ives, J. Kresge, M. Kofira, C. Evans, R. Begley, J. Ungemach, B. Kurz, T. Casey, J. Gicerowski, L. White, J. Bardalamas, K. Alger, D. Swartwood 3 T. Owens, C. Carr, J. Pratt, M. Jenks, L. Chamberlain, L. Beam, L. Johnson, S. McDonald, J. McKeon, M. Lawrence, B. Mellem, V. Pezzino, O. Spicer, K. Guglielmo, N. Williams, J. Henninge, J. Brown, A. Barnes 4 V. Bauer, J. Price, D. Koopman, Tuttle, J. Marvin, N. Brennesholtz, J. Clark, K. Kinne, M. Unsell, J. Hall, D. Madara, A. Kalicicki, non-member, E. Hughes, V. Preston, R. Fagnoli, N. Cline, T. Fyfe, A. Bennet, C. Carter, E. Browning, T. Beach, K. Haines 5 T. Clark, N. Simpson, S. Callahan, M. McMahan, E. Case, M. Rott, D. Bidwell, D. Stolarczyk, D. Burkholder, K. Weir, T. Short, J. Garnar, M. Williams, M. Price, J. Henninge, S. Sterling, E. O'Hearn, Kennedy, B. Cannarella, A. Campbell, C. Flanagan, P. French, M. Garbett 6 L. Colebrooke, D. Campbell, D. Richter, non-member, S. Vangiesen, non-member 7 B. Eggleston, O. Moore, N. Sen



CHAMBER CHORUS AND JAZZ BAND

E. Cannon, S. Eggleston, J. Pratt, R. Salyards, M. Root, K. Ruth, M. Kofira, L. Johnson, M. Unsell, L. Chamberlain, J. Price, J. Hall, N. Cline, M. Price, A. Ungemach, B. Kurz, T. Fyfe, C. Carter, D. Campbell, B. McKeon, S. VanGiesen, M. Lawrence, D. Richter, D. Madara, J. Garner, K. Weir, M. Williams, A. Kalicicki, D. Burkholder



Row 1, D. Madara, J. Garner, T. Short, K. Weir, E. Hughes, J. Bardalamas R-2 T. Berkering, M. Herrick, B. McKeon, V. Pezino, Mr. Rohrbach



I N D O O R

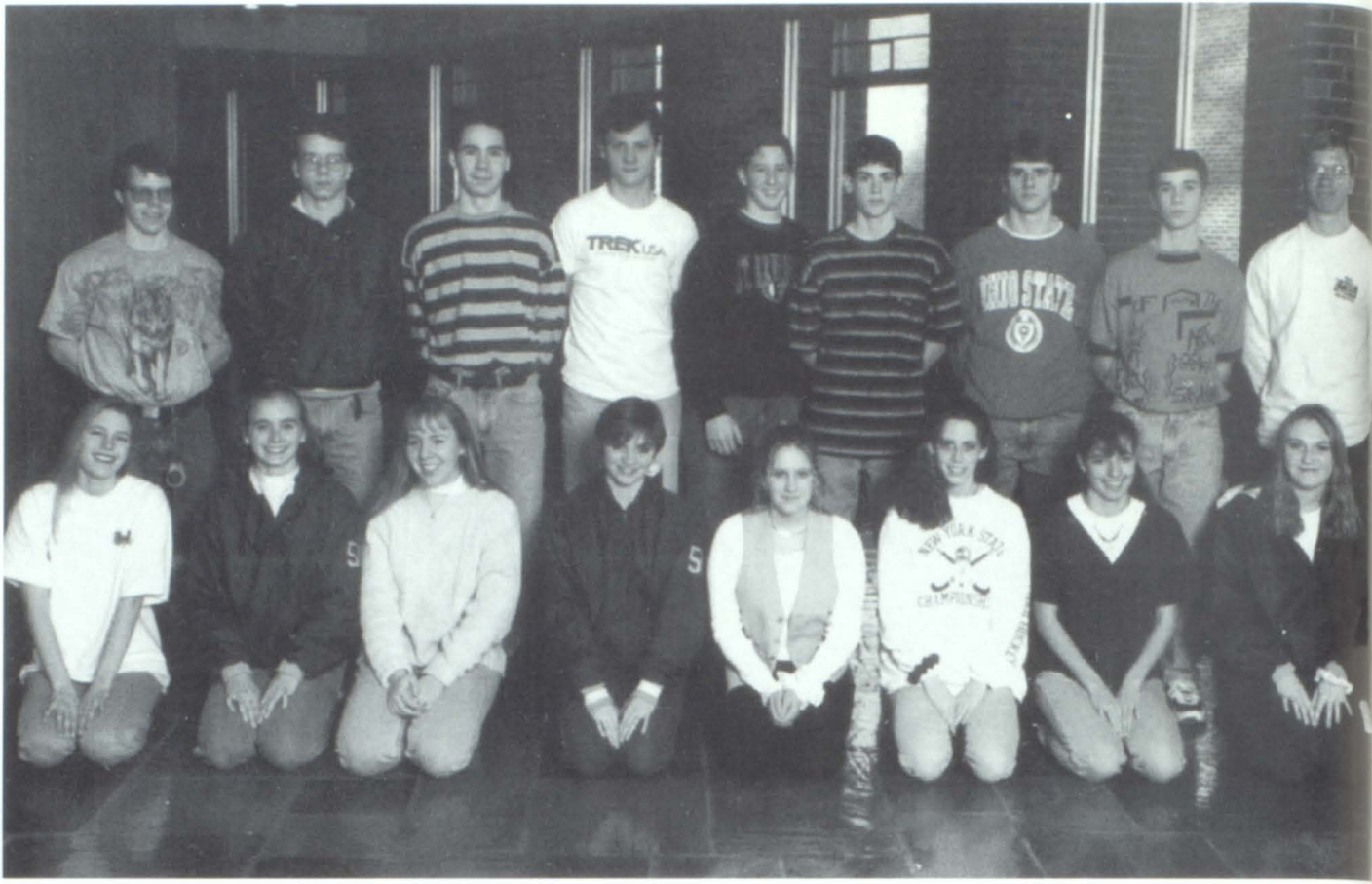

Row 1 L-R S. Welch, V. Bauer, C. Carter, J. Hall, B. Sage, V. Flowers, A. Crandall, N. Hall 2 M. Lawrence, B. Mellem, J. Youngs, T. Beckering, T. Fyfe, Flowers, A. Kalicicki, M. Whitney, W. Barnes

T R A C K





FACULTY and STAFF

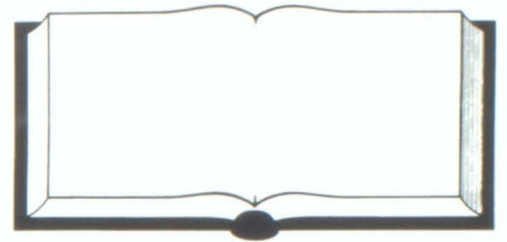

ENGLISH

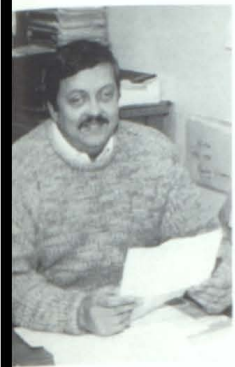

B. Cline



K. Mouillesseaux



A. Riggs



J. Storman

MATH



S. Burghardt



W. Cook



J. Mason



B. Daniels

SCIENCE

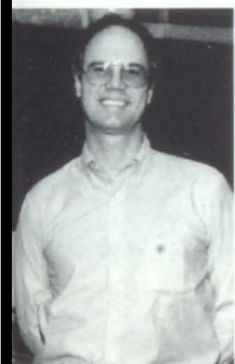

T. Wolcott



L. Golicki



B. Petrie



J. Treyz

HISTORY



M. Granan



L. Mazzitelli



M. Martin



B. Case



SPECIAL EDUCATION



S. Bertram



A. Fiato



E. Cline



C. Ferguson



A. Neudel



E. Schuchman



T. Place



R. Stefan

GUIDANCE

Missing: J. Miller



L. McGrath



P. Danforth

LIBRARY

READING

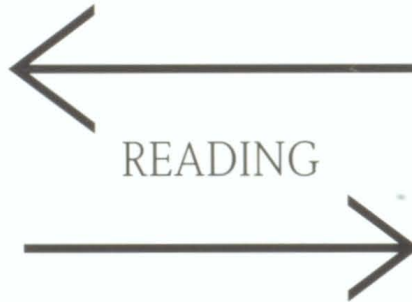

L. Clark-Pfleger



S. Davis



N. Barrows



R. Smith

PHYS. ED.

MUSIC

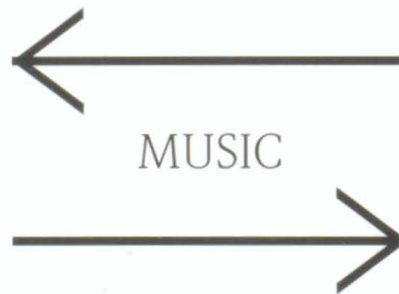

S. Monsour



M. Rohrbach

A.V. OFFICE



MAIN OFFICE



HEALTH



K. Lommerin



J. Taylor



D. Thomas



K. Hickey



J. Kurz



J. Hall



R. Philippone



M. Knaub

LANGUAGE



ARTS



BUSINESS



W. Danley



K. Faruzel



A. Woodward



M. Vizvary

A.D. OFFICE



I.S.S. & R.E.M.



D. Bennett



S. Silvernail



S. Van Woert

SOCIAL STUDIES

Don't Run, Take the Money

HELLO... JUDGE ITO? CAN I BE SEQUESTERED WITHOUT BEING ON THE JURY?

THE QJ NETWORK (ALL ON ALL THE TIME)

Sole men: The Beastie Boys lace up.

BEFORE SUNRISE

Dino DNA?

DUMB AND DUMBER

Information Superhighway

NEWT GINGRICH

ski Lake and her disciples have achieved the possible: lowered the standards of TV gabfests

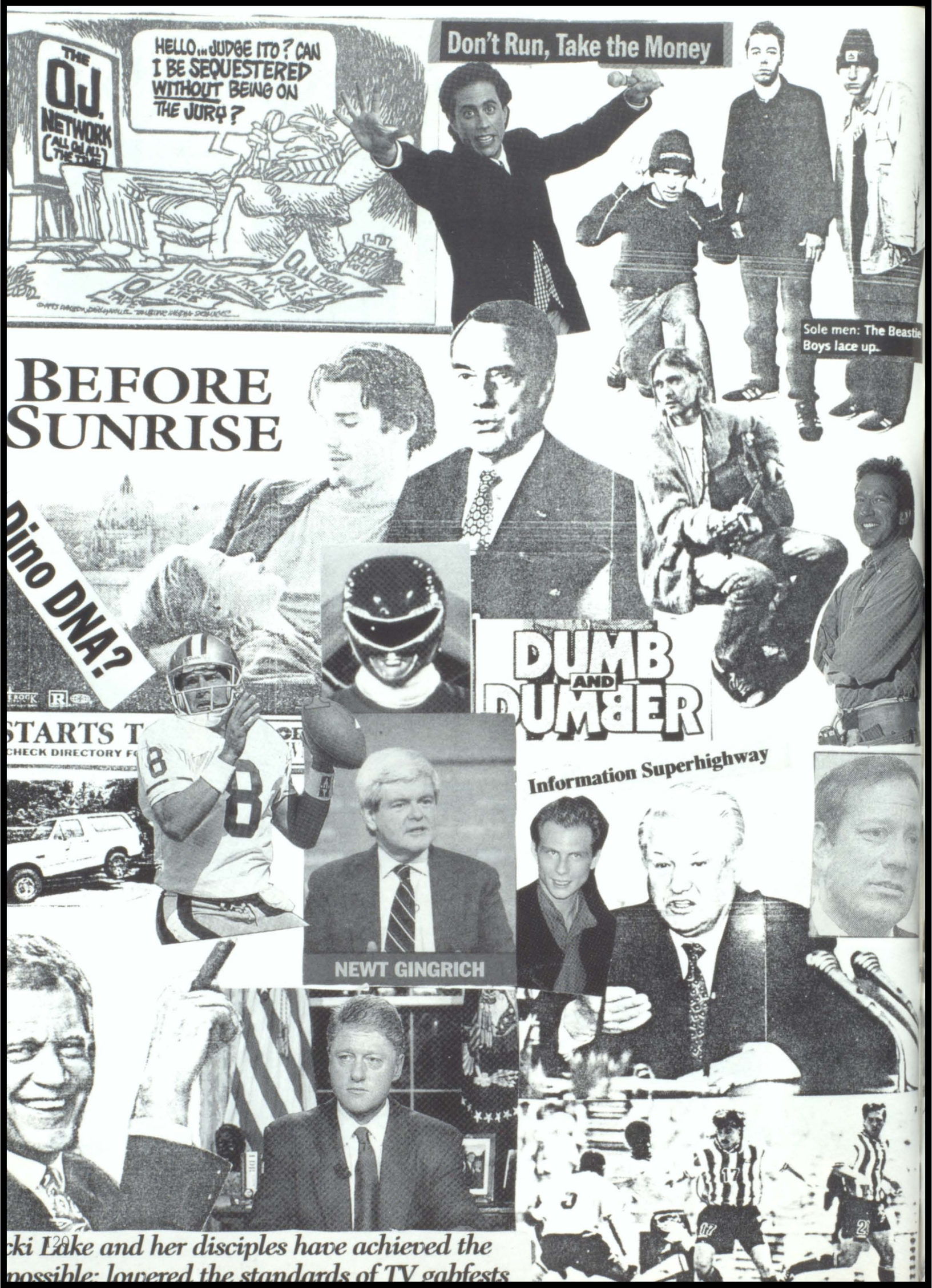



LEGENDS
of the
FALL

My So-Called Life

Tom Hanks is Forrest Gump

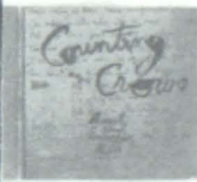

A Disaster for the Royal Family



CUSTODIANS



Back — R. Furgeson, A. Beebe, G. May, J. Biles, D. Sherman, M. Utter, S. Funnel, B. Bodine, 2 — F. Bailey, R. Samson, T. Elmore, 1 — M. Gerst, G. Homza, M. Sherman, P. Clements

CAFETERIA



D. Jones, J. Lucier, L. Martin, W. Franklin, C. King, I. Bush, R. Badger

DISTRICT ADMINISTRATION



DISTRICT SUPERINTENDENT DR. FREDERICK TAROLLI

BOARD OF EDUCATION



Back Row Keith Day, Dr. Frederick Tarolli, Kenneth Harrington, Richard Brown Front Row Chris Austin, Ethel Gibson, Mildred Pixley, Maryalice Butler. Missing — Allan Mackinnon

RAYMOND

Congratulations Graduates!

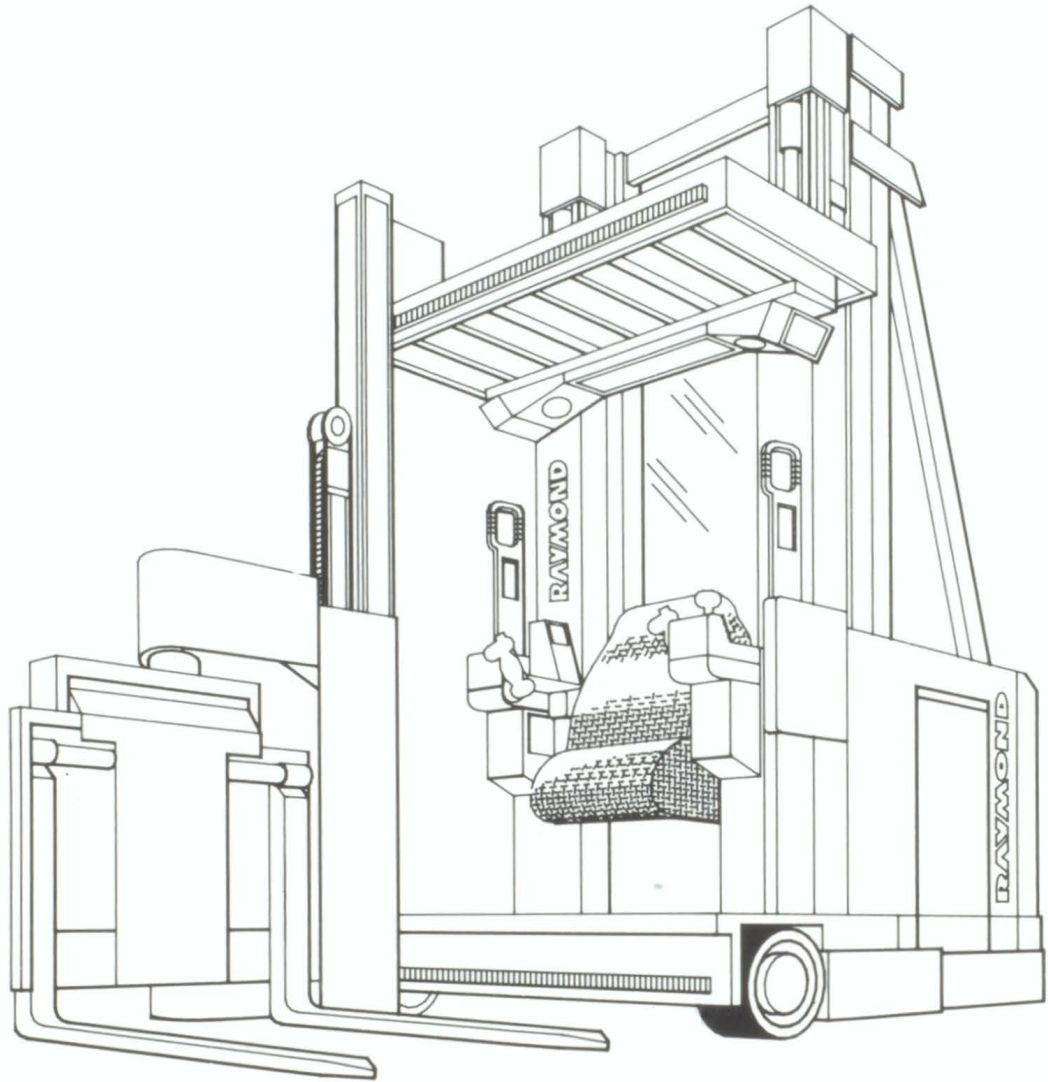

**From The Raymond Corporation
Corporate Headquarters
Greene, New York**

*Congratulations and Best Wishes
to the Class of 1995 !*

GREENE OFFICE

80 South Chenango Street
Greene, New York 13778

Office 607/656-4141 Fax 607/656-9129

NBT *The National Bank
and Trust Company*



MEMBER FDIC

Working with you. Working for you.

Sidney Federal Credit Union

42 Union Street
Sidney, NY 13838
(607) 563-9100

Great American Plaza
Walton, NY 13856
(607) 865-4155

65 Genesee Street
Greene, NY 13778
(607) 656-7111



SIDNEY FEDERAL
CREDIT UNION

Corner of Rt. 23 & E. River Rd.
Norwich, NY 13815
(607) 334-2492

53 Market Street
Oneonta, NY 13820
(607) 432-0057

1 Credit Union Plaza
Bainbridge, NY 13733
(607) 967-7100

Your one-stop financial institution would like to
Congratulate the Class of 1995!!!
SFCU, its our community too...

SINCE 1925

TRI - TOWN INSURANCE

WE' RE LOOKIN' OUT FOR YOU!

Whitney Point 692 - 3350

Afton	Bainbridge	Endicott	Nichols	Owego
639-2255	967-2241	785-1300	699-3081	687-1381

PENSIONS - INDUSTRIAL - BONDS - HOME - AUTO - LIFE

CHENANGO BRIDGE MEDICAL GROUP



BOARD CERTIFIED SPECIALISTS IN:

Family Practice, Performing Obstetrics
Internal Medicine
General Surgery
Vascular Surgery
Pediatrics
Neonatology
Cardiology, with Cardiac Catheterization
Hematology
Oncology

ADDITIONAL SERVICES IN CHENANGO BRIDGE:

Convenience Clinic After Hours	Cardiac Diagnostics
Sports Medicine	Laboratory
Physical Therapy	X-Ray & Mammography
Colonoscopy	Ultrasonography

WHITNEY
POINT
OFFICE



CHENANGO
BRIDGE
OFFICE



FRONT ST.
OFFICE



HALLSTEAD
OFFICE



GREENE
OFFICE

Appointments Call:
648-4141

General Information
Call:

Chenango Bridge Rd,
Chenango Bridge, NY
648-4101

Whitney Point Office
692-3600

Greene Office
656-4115

Front St. Office
771-7381

Hallstead Office:
717-879-2142

VIEIRA AND SKIADAS Certified Public Accountants

E. Mark Vieira, CPA
Ernest Skiadas, CPA
Mark J. Stanley, CPA

OUR BEST WISHES TO THE GRADUATING CLASS OF 1995!

Offices located at:

62 Genesee Street
Greene, New York 13778
(607) 656-7574

5 Leroy Street
Binghamton, New York 13905
(607) 723-1272

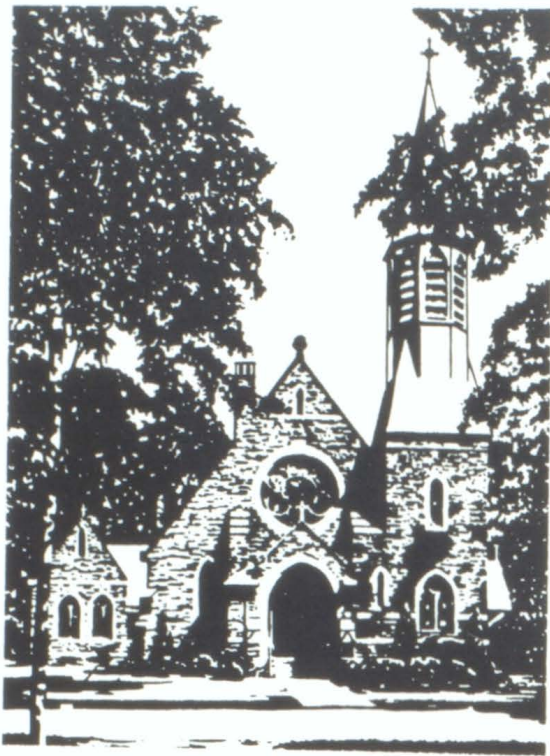

Congratulations to the
1995
Graduates

from the
ZION EPISCOPAL CHURCH

CONGRATULATIONS

AND

BEST WISHES

CLASS OF 1995



Empire Natural Gas Corporation
RD 2, Box 412
Airport Road
Greene, New York 13778

CONGRATULATIONS

1995 GRADUATES

FROM

**GREENE TECHNOLOGIES
INCORPORATED**

Imagineering with metals.

METAL FABRICATION • WIRE FORMING • STAMPING
SHEET METAL • MACHINING • TUBE BENDING • WELDING
PLATING • COATING • PAINTING • ASSEMBLY

GRAND AND CLINTON
STREET

GREENE, NY

13778-0616



JOIN PTA

PEOPLE

TAKING

ACTION

GREENE CENTRAL SCHOOL
ELEMENTARY PTA

"PARENTS AND TEACHERS
WORKING TOGETHER"



ROOT FUNERAL HOME

23 NORTH CHENANGO ST.
GREENE, NEW YORK 13778
607-656-4212

Mr. Edward Winchell
Mr. Charles Dietrich



33 North Chenango St.
Greene, New York 13778
Phone (607) 656-4700

ESTHER M. EVANS
Licensed Real Estate Broker



Multiple
Listing
Service
MLS

OUR STAFF WISHES THE BEST
OF LUCK TO THE 1995 GRADUATES

Theresa C. Rosekrans,

Lic. Real Estate Broker

Otis F. Wightman,

Lic. Real Estate Broker

Glenn A. Day,

Lic. Real Estate Broker

Marilyn S. Villante,

Lic. Sales Associate

BEST WISHES



1995
GRADS

FROM,
The
Greenelite Staff

G.D. ELLIS AUTO SALES

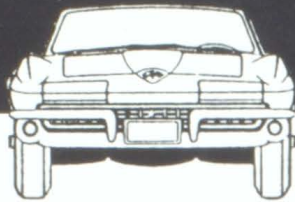

68 S. Canal Street
Greene, NY 13778
607-656-9660

HOURS:
10 am - 6 pm/Mon.-Fri.
8 am - 3 pm/Sat.
-or by appointment-

Fully Serviced and Reconditioned
Quality Cars • NYS inspected and guaranteed

TELEPHONE (607) 656-4664

JOSEPH E. NELSON, D.M.D.

OFFICE HOURS
BY APPOINTMENT

MEDICAL ARTS BUILDING
29 NORTH CHENANGO STREET
GREENE, N.Y. 13778

LARKIN LAW OFFICE
ATTORNEYS AT LAW

ROBERT M. LARKIN

BUS. PHONE
(607) 656-4515
FAX. PHONE
(607) 656-9016

36 GENESEE STREET
GREENE, NEW YORK 13778

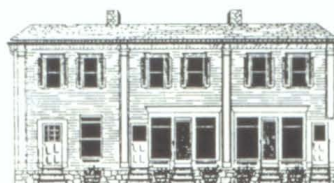

THE OLD COUNTRY STORE

ANTIQUES • COLLECTIBLES

Jim & Shirley Nord

(607) 656-9070

2 S. Chenango St.
Greene, New York 13778

The Chenango American

Whitney Point Reporter and Oxford Review-Times

YOUR HOMETOWN PAPERS

P.O. Box 566, 12 S. Chenango St.,
Greene, NY 13778
607-656-4511 • Fax 607-563-7118

MARC FELDMAN, D.D.S.
COMPLETE FAMILY DENTAL CARE

70 GENESEE STREET
GREENE, NEW YORK
656-7676

Sergi's Well Drilling

RD #2, Box 773-B, Greene, N.Y. 13778

Pump Systems - Water Conditioners

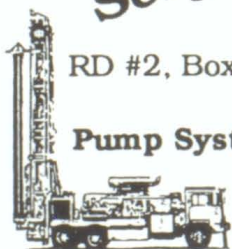

Mike Sergi - 656-8442

Congratulations Veronica

Whitney Insurance Agency

Insurance and Financial Services
A Member of Mang Group, Inc.

Karen W. Smith, Broker

2 So. Canal St.
P.O. Box 602
Greene, New York 13778-0602
(607) 656-5100



Church of the Immaculate Conception

20 Coventry Road
Greene, New York 13778

(607) 656-9546



“WE SHALL NOT BE SILENT
NOR SHALL THE EARTH
REMAIN UNMOVED”
GOOD LUCK
GRADUATES

BEST WISHES
CLASS OF
1995



BENNETT'S FOOD
MARKET
47 GENESEE STREET
GREENE, NY 13778

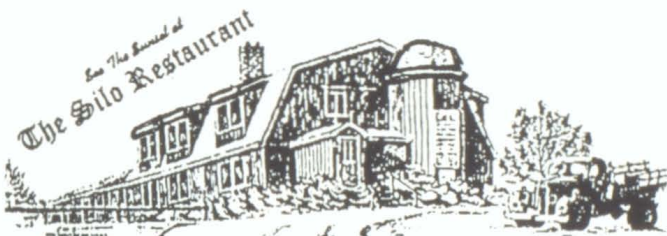

*See The Sign at
The Silo Restaurant*

**Known For Our Fabulous
STEAKS • FILETS • SEAFOODS • PRIME RIBS
VEAL • CHICKEN DISHES**

- Banquets to 300
- Picturesque Wedding Receptions
- Overnight Guest Rooms
- Cocktail Lounge
- Dinner & Limo Packages
- Meetings
- Private Luncheons
- Business Seminars, Meetings
- Breakfast, Lunch, Dinner

Friday Night Seafood Buffet Extravaganza Every Friday 5-10 PM	ALL MAJOR CREDIT CARDS ACCEPTED For Reservations Call 656-4377	Sunday Brunch Every Sunday 10 AM - 2 PM
---	---	--

RT. 205 TO MORAN RD. • 6 MI. EAST OF GREENE, NY
10 MI. WEST OF BAINBRIDGE
Scenic View, Worth The Trip! Open 7 Days

**Complimentary Horse & Buggy Rides
7 Days a Week Provided by
Chenango Valleys Hitches
(Weather Permitting) • 8-9 PM / Sun 12-3**



CONGRATULATIONS AND
I WISH I WAS THERE
LOVE,
JOSHUA BREWSTER

Hours
Mon.-Fri. 7-6
Sat. 7-4



G & L AUTO SUPPLY

SUPPLIES, SERVICES & REPAIRS

GUY HURLBURT • LIZ DICKERSON
RD 2 Rt. 12S GREENE, NY 13778
(607) 656-7239

ROSEKRANS LAW OFFICE

Attorneys at Law

62 Genesee Street
P.O. Box 558
Greene, N.Y. 13778
Tel. (607) 656-5171

FRED A. ROSEKRANS

JOHN C. ROSEKRANS



Fueling New York Yesterday,
Today and Tomorrow

GREENE DIVISION

13 Cherry St.
(607)656-4211



Delivered to the job for

FOUNDATIONS
DRIVEWAYS
PATIOS
CELLARS

- Washed Sand
- Crushed Gravel
- Concrete



NORWICH, NY
Phone 336-7880

B & B Builders' Supplies Inc.
GREENE, N.Y. 656-4145

BAINBRIDGE, N.Y.
Phone 947-4912

FUTURE BEST WISHES

KENNEDY FUNERAL HOME

21 NORTH CHENANGO STREET

GREENE, NEW YORK 13778

607-656-7714

1-800-836-2550



"A Practice of Caring"

656-4285

*Congratulations to the Class of 1995
from*

**The Greene Veterinary Clinic
and Staff**

"Between dreams and reality is a lot of effort!"



"CELEBRATING OUR
99TH ANNIVERSARY"

ROSEKRANS LAW OFFICE
Attorneys at Law
62 Genesee Street
P.O. Box 558
Greene, N. Y. 13778

Tel. (607) 656-5171

FRED A. ROSEKRANS

JOHN C. ROSEKRANS

Parents have their say

Sean Breslin

We're proud of you. Best of luck as you continue your journey. Love you!
Mom & Dad



Beth Anne Brown

We are so blessed to have such a beautiful daughter. You deserve so much respect. We know you'll succeed in everything you do. Please remember we are just a phone call away.

Love,
Mom & Dad

Cathy Jo Carter

You are a bright and shining star in this world. Follow your dreams and be wise in your decisions. We're so proud of you! Stay close to the Lord and remember I love you always.

Mom

Seth Kirchbaum

Dear Seth,
As you graduate, we wish you love and happiness in your future! But remember you will always be our "little punkin"

Love always,
Dad & Mom



Corey Robin Centerwall

Congratulations! Your life will be an exciting journey if you always aim for your dreams and stay true to your heart — your rewards will follow! "Say good night, say okay."

Love Mom

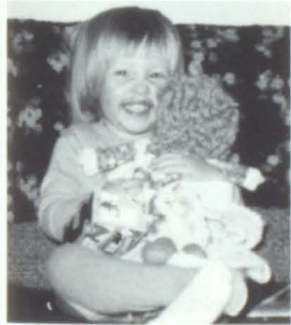

Carolyn M. Jackson

Reach for your goals and hang on but don't forget the journey is as important as the goal. Keep your smile and use it often. We love you.

Mom & Dad



David P. Madara

You've brought joy to each life you have touched and pride to the many who have guided you as you've grown. Now, a wonderful future awaits you. Congratulations!

Love,
Mom & Dad

Denny Burkholder

Denny,
Go for it! You're the best and you deserve the best life has to offer. You make us proud!

Love, Mom & Dad



Todd Ray Short

Todd,
You have always been unique and although we don't always agree, we're proud that you know your own mind and aren't swayed by the crowd. Congratulations Baby Boy — we're so glad God gave you to us.

Mom & Dad



Megan Hickey

Meggie,
Congratulations! We're so proud of you
and all of your accomplishments. Follow
your heart, lead with your head and fulfill
your dream. Then . . . SPIKE IT DOWN!!!

Love,
Mom, Michelle, & Kris



Timothy Winston

Never lose that sweet smile. We're
proud of all you've done. We love you
and we'll miss you.

Love, Mom & Dad



Claudia Oliphant

You're a great tennis player. You
have great determination and we
know you will go far.

Mom & Dad



Todd Eldred

Todd:
We hope you have all the success you
deserve. You have worked hard and we
are proud of what you have accom-
plished.

Congratulations,
Mom & Dad



Brian Mellem

We love you and wish you God's best,
always remember "I can do all things
through Christ which strengthen me."
Phil. 4:13

Mom & Dad



Karen Haines

You are so special and we're very proud of you! Dream beautiful
dreams, but work hard for your goals. Take time to think wisely.
Remember God loves you, and so do we!

Love always,
Mom

Aaron Pry

Pursue your goals today to achieve to-
morrow's dreams for lives too short to wait
until the next day. We're very proud of you
— Enjoy life

Mom, Larry, & Melanie



Jeff Warren

No matter where you are, just remember
we think the world of you and love you
very much.

Love,
Steve, Mom



Aaron Heisler

Bucky,
As your parents, we're proud of your accom-
plishments. We admire your values, sense of
humor, work ethic and your personality. But
most of all, we enjoy calling you our friend.

With love,
Dad and Mom



Sabrina Holcomb

Always stay the best that you are and you will do great in life. Watch out
for those blonde moments! We love you.

Love always,
Mom & Dad

Riley Salyards

You have been such a wonderful part of our lives. Keep Greene in your heart as you venture out into the world. With all our love.

Sandie, Jim
Tracey and Becky



Elaine White

We have seen you through good times and bad times. You have worked very hard to arrive at this special day in your life. We're very proud of you, Congratulations.

Love,
Mom, Dad, and Helen



Emily McCabe

You're ready to take on the world, Em. Make us as proud of you as we've always been. Love and Luck!

Mom, Dad, & Tom

Emily Case

You've filled our lives with love, wonder, and memories to be treasured as we've grown through these years together. We're so very proud of the person you've become. Our love and support are with you always.

Mom and Dad



Becky Brownell

It's been a joy watching you grow into a lovely young lady. Stand fast to your high ideals and go forth with faith, love, and laughter. Congratulations!

Love, Mom



Jason Garnar

Dear Jason,
The curly hair may be only a childhood memory, but the curious mind is still asking questions and seeking answers. Your caring and reconciling nature has enriched our lives, and will touch countless others in the years to come.

Love,
Mom, Dad, Gram, & Seth



Dan Richter

May you always "break a leg" and let your sun-shine. God bless you.

Love, Mom and Dad



Leslie Valentine

The last chick leaving the nest. She will fly far with God and her father watching over her.

Love you and best wishes —
Mom

Nicole Hall

"Must be a bad hair day" You fill our lives with love and laughter.

Love,
Your parents



Melissa Frost

Melissa (Peanut),
Growing up has been an "experience" for all of us. We are proud of you and love you deeply. Be happy and successful in the pursuit of your dreams.

Love, Mom, Dad, and Wes



Dear Hali,
 You will always be Daddy's little girl no matter how old you get and the sweetness in your Mother's heart. We all love you.

Dad, Mom, Kylie, Autumn,
 Joslynn, & Ben



Stephanie Carey

Turn around and you're four Turn around and you're a Senior going out of our door We are so proud of you You can achieve anything you want You proved it.

All our love,
 Mom & Dad



Chris Woolston

You grew up the day you had your first laugh at yourself. I know now you'll grow wise and kind, ultimately experiencing success.

Love, Mom



Christopher Button

Chris,
 You've always shown a special love for animals and people, bringing laughter and a love for life. Don't ever lose this and your future will be great. We love you!

Mom & Dad



Dan Gaus

Thanks for all the memories! We are so proud of you and your accomplishments! We LOVE and RESPECT you and wish all your dreams come true, You deserve them!

Love, Mom, & Dad

Christine Ann Smith

Chris,
 You make us proud and happy. We all love you. Stay the caring person you are.

Love,
 Mom, Dad, and Nikki



Benjamin Eggleston

Ben,
 You're a good son and brother. We love you with all of our hearts and wish you the best. Good luck to the Best Big Brother in the world!

Love,
 Mom, Dad, & Kids



Jason Amell

Dear Jason,
 We are very proud of you. We wish you the best in life, and remember we are always here for you. We love you.

Dad and Mom



Wendy A. Cooper

Through the years as you have grown, we've watched you make many accomplishments, with the future only to bring you many more. Proud of you always.

Love, Mom & Dad

Ron Utter

We are proud of you. Best of luck in everything you do. P.S. Your still bald and a wise guy. We love you son.

Dad & Mom



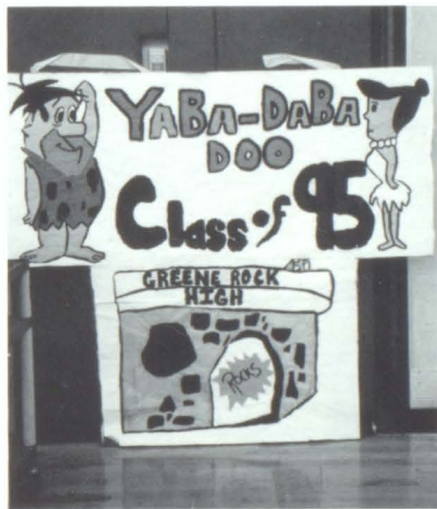

Class of 1995

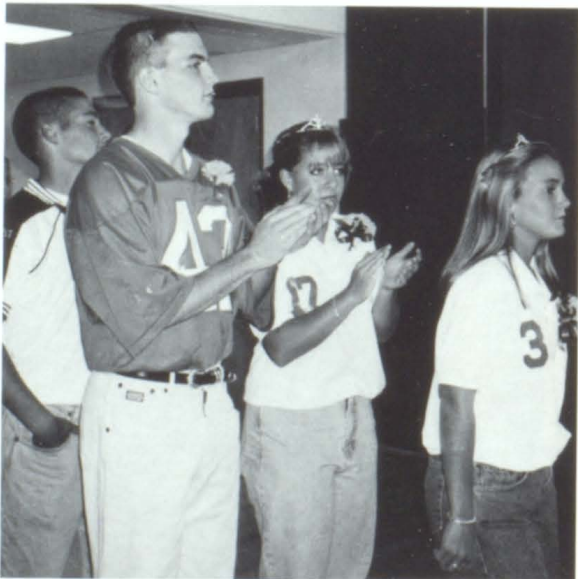

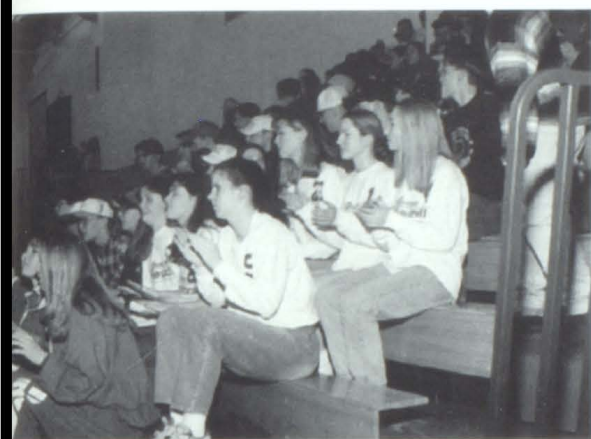

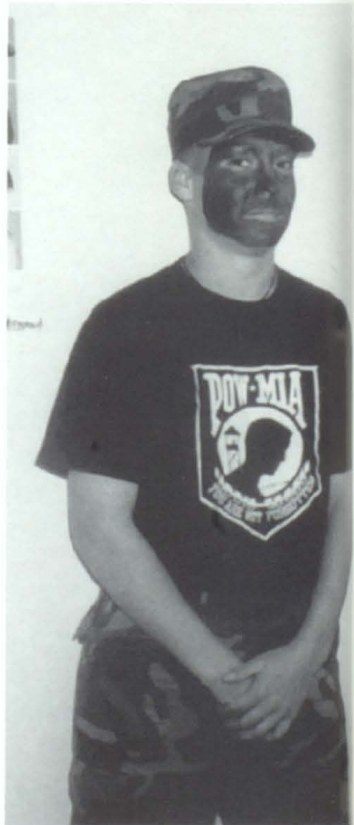

SOPHOMORE CLASS

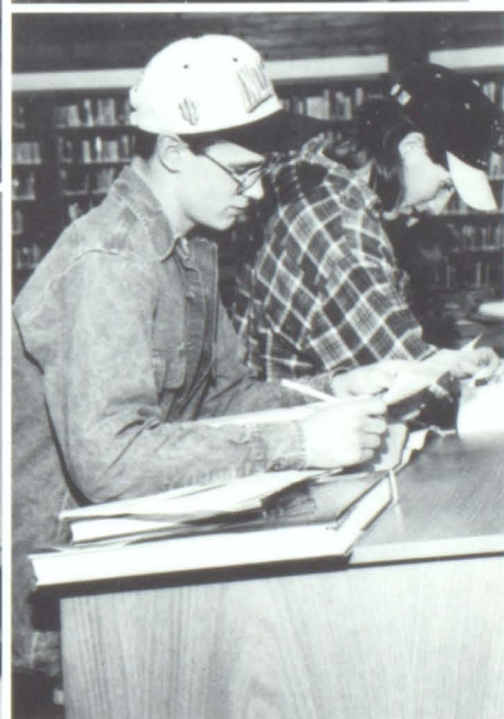
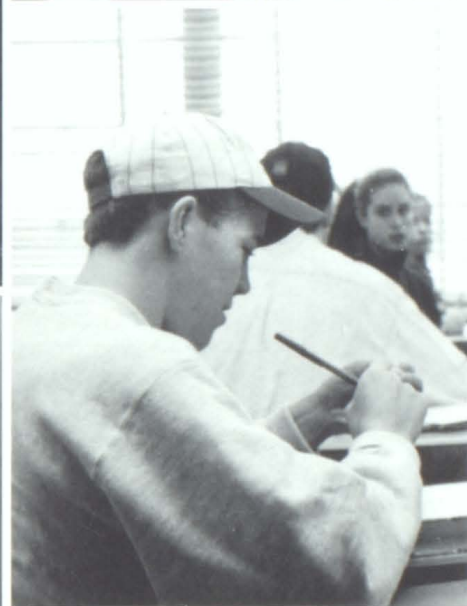

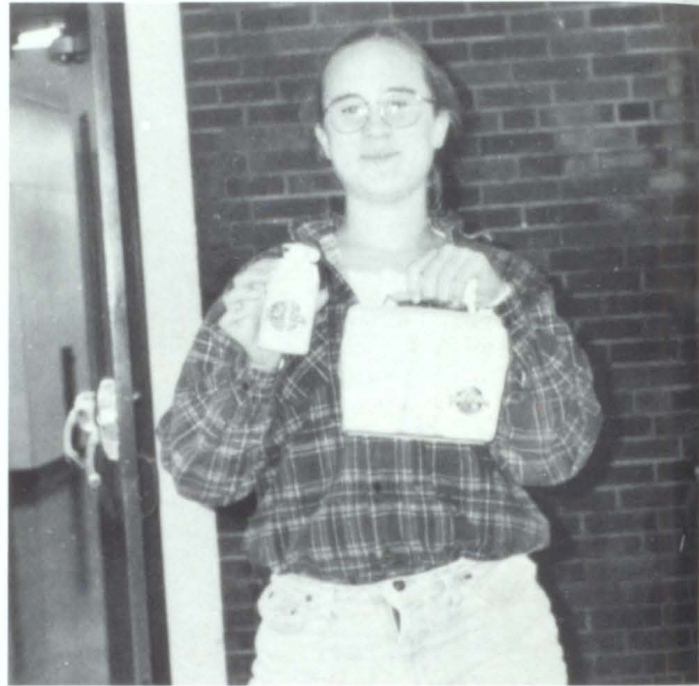

F
R
E
S
H
M
A
N
C
L
A
S
S

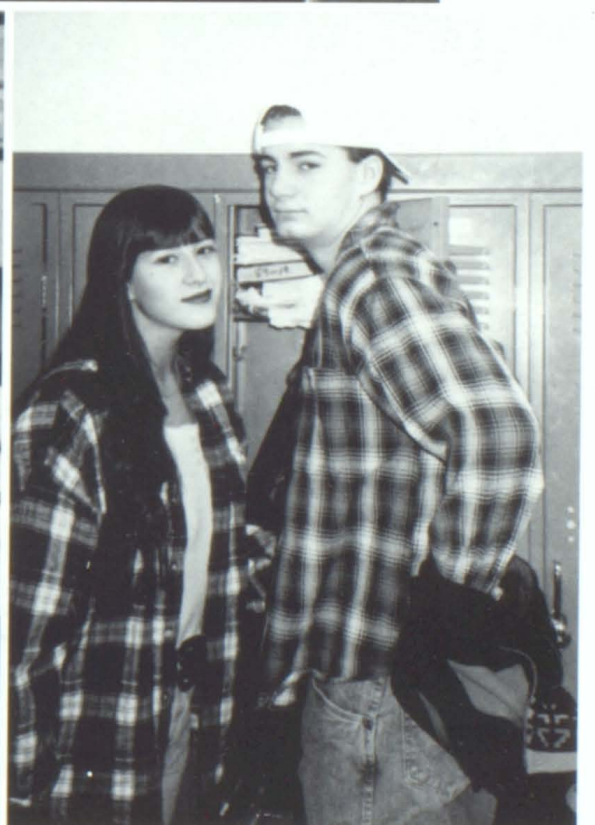
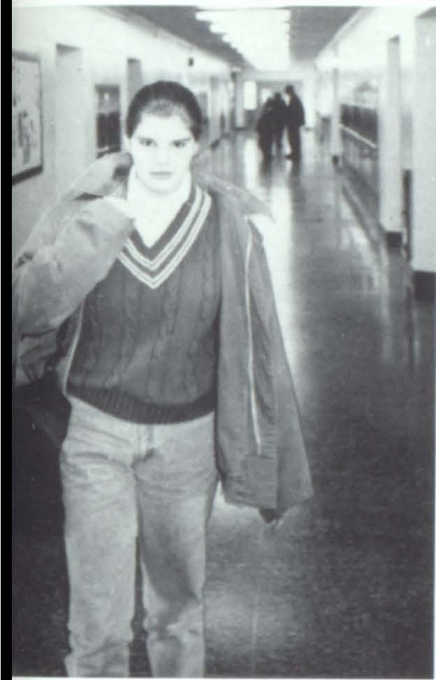

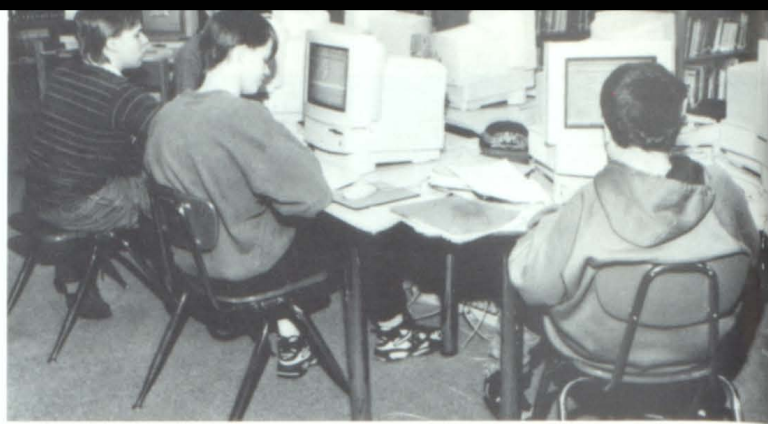

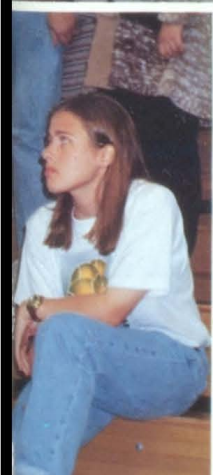
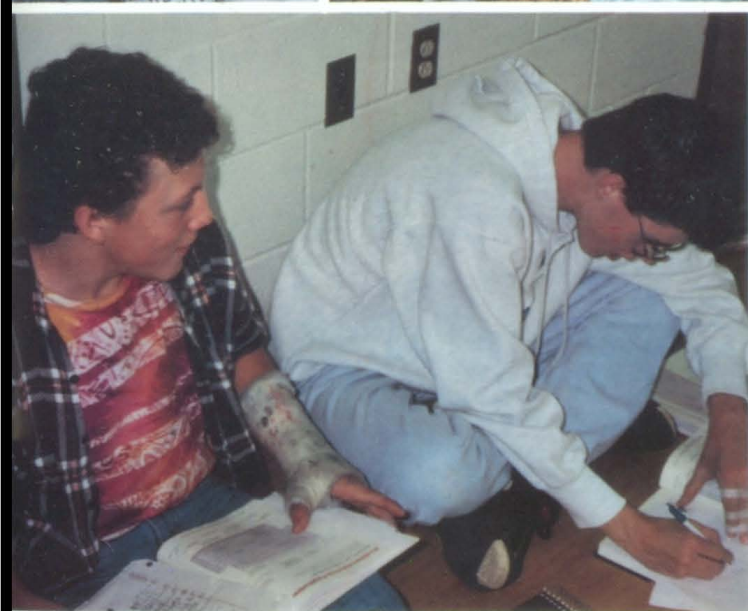
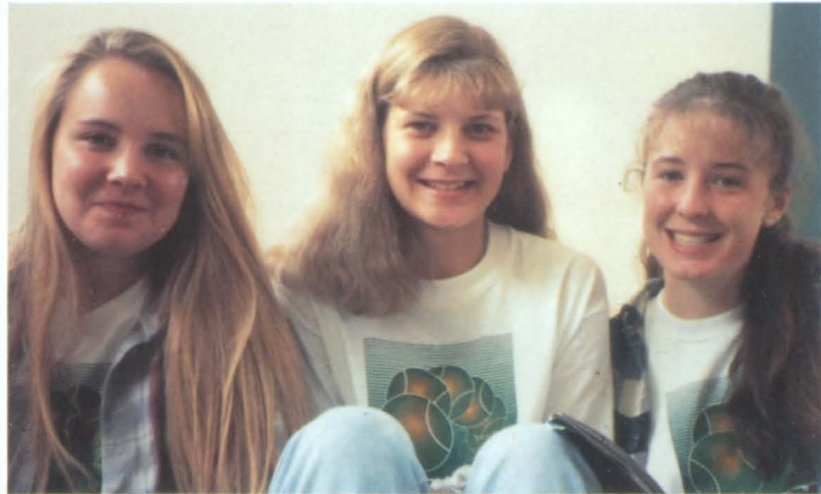
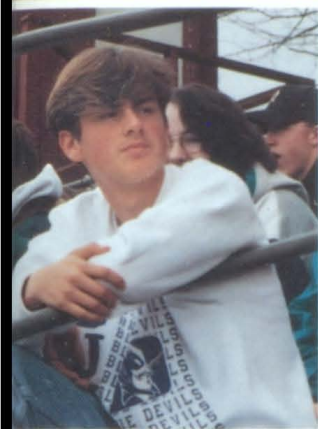

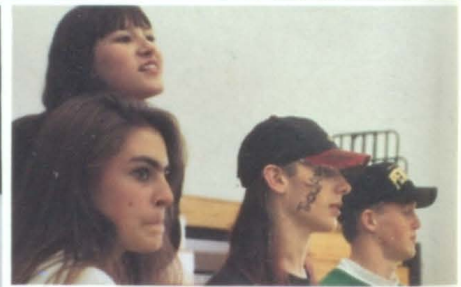
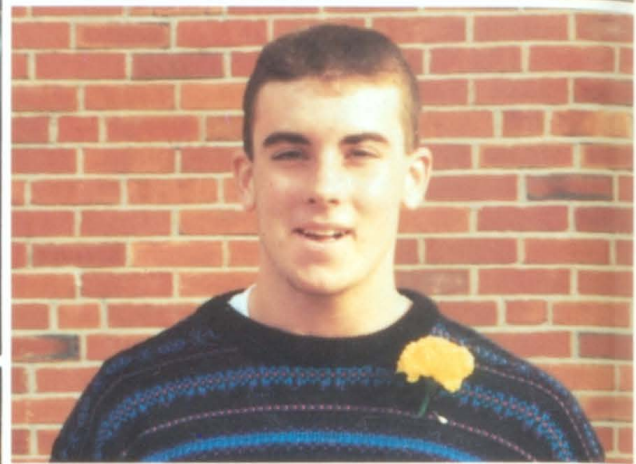
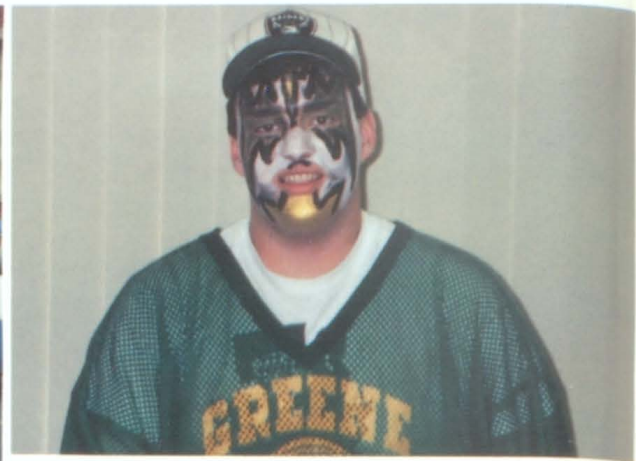

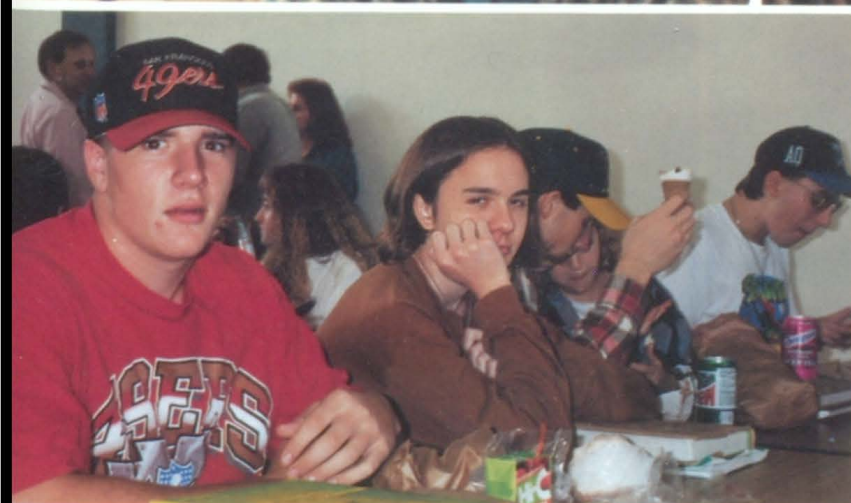
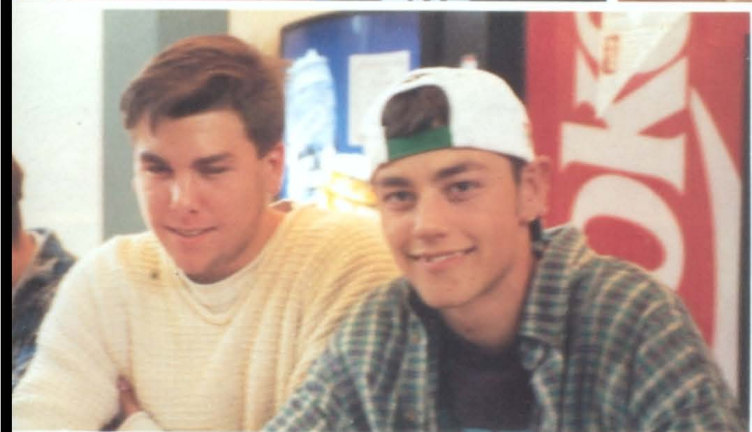
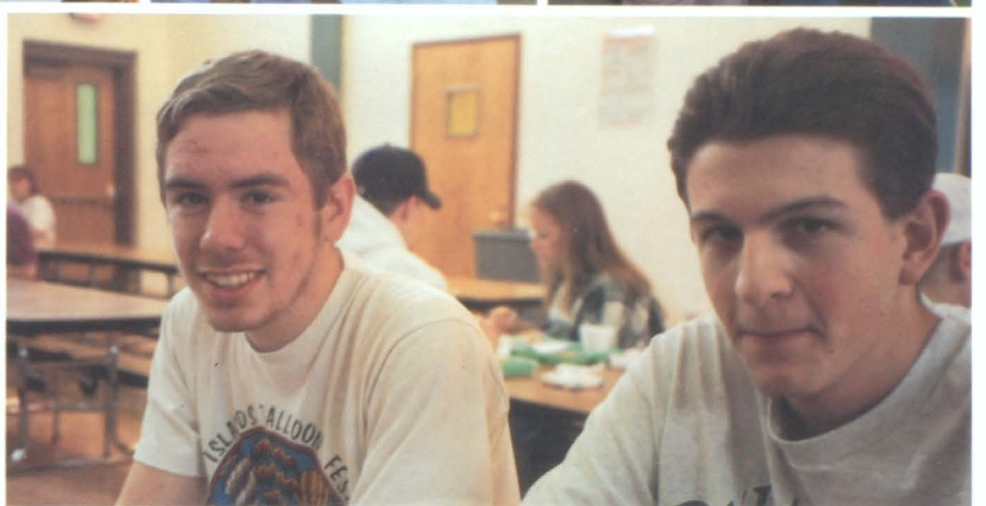
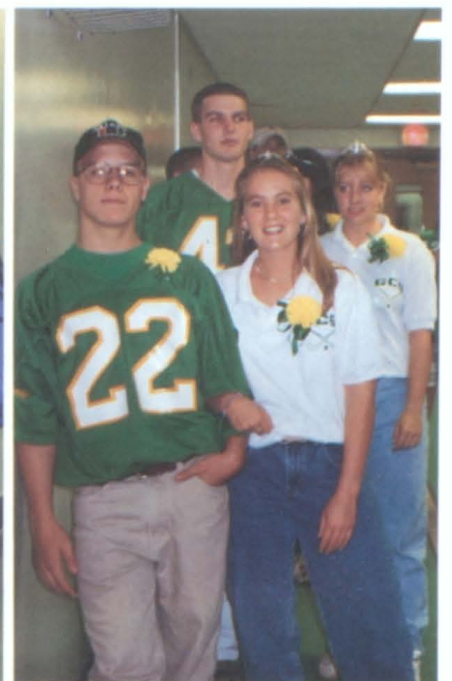
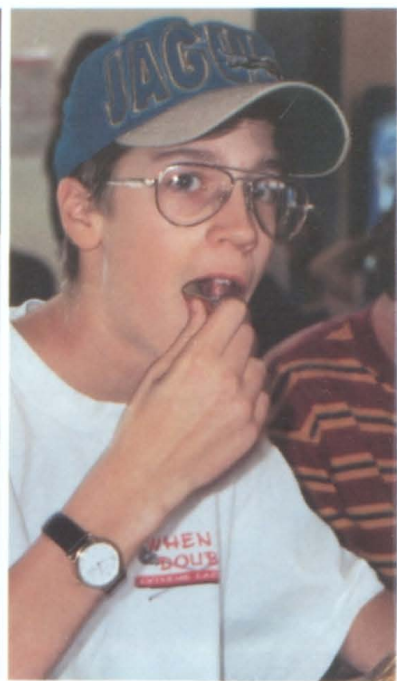

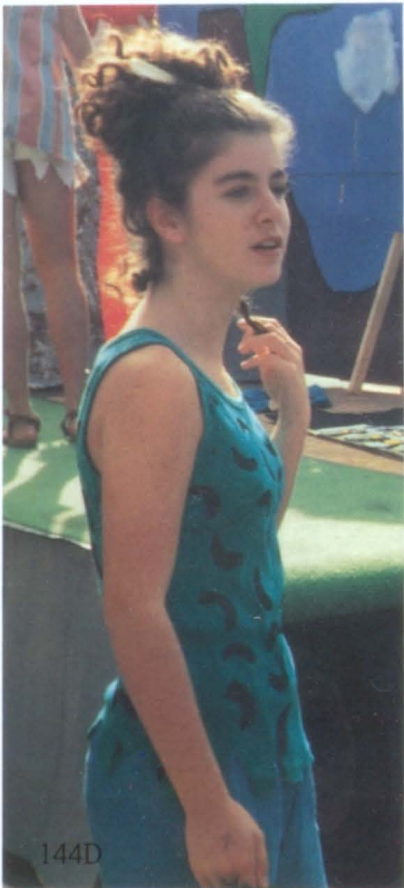
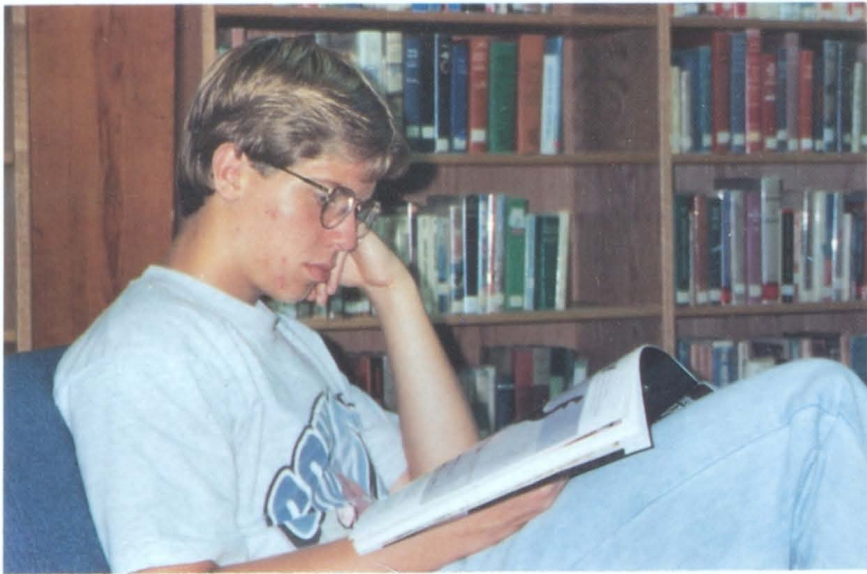
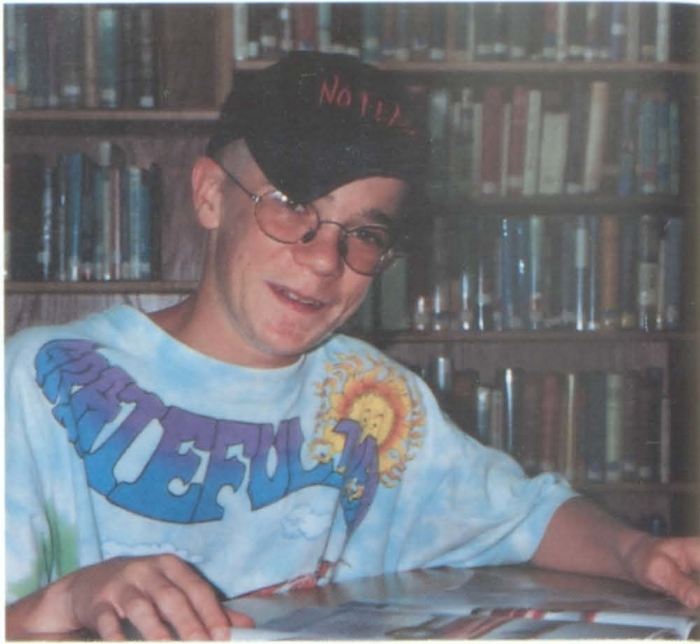

AUTOGRAPHS

AUTOGRAPHS

AUTOGRAPHS

AUTOGRAPHS

AUTOGRAPHS

AUTOGRAPHS

AUTOGRAPHS

AUTOGRAPHS

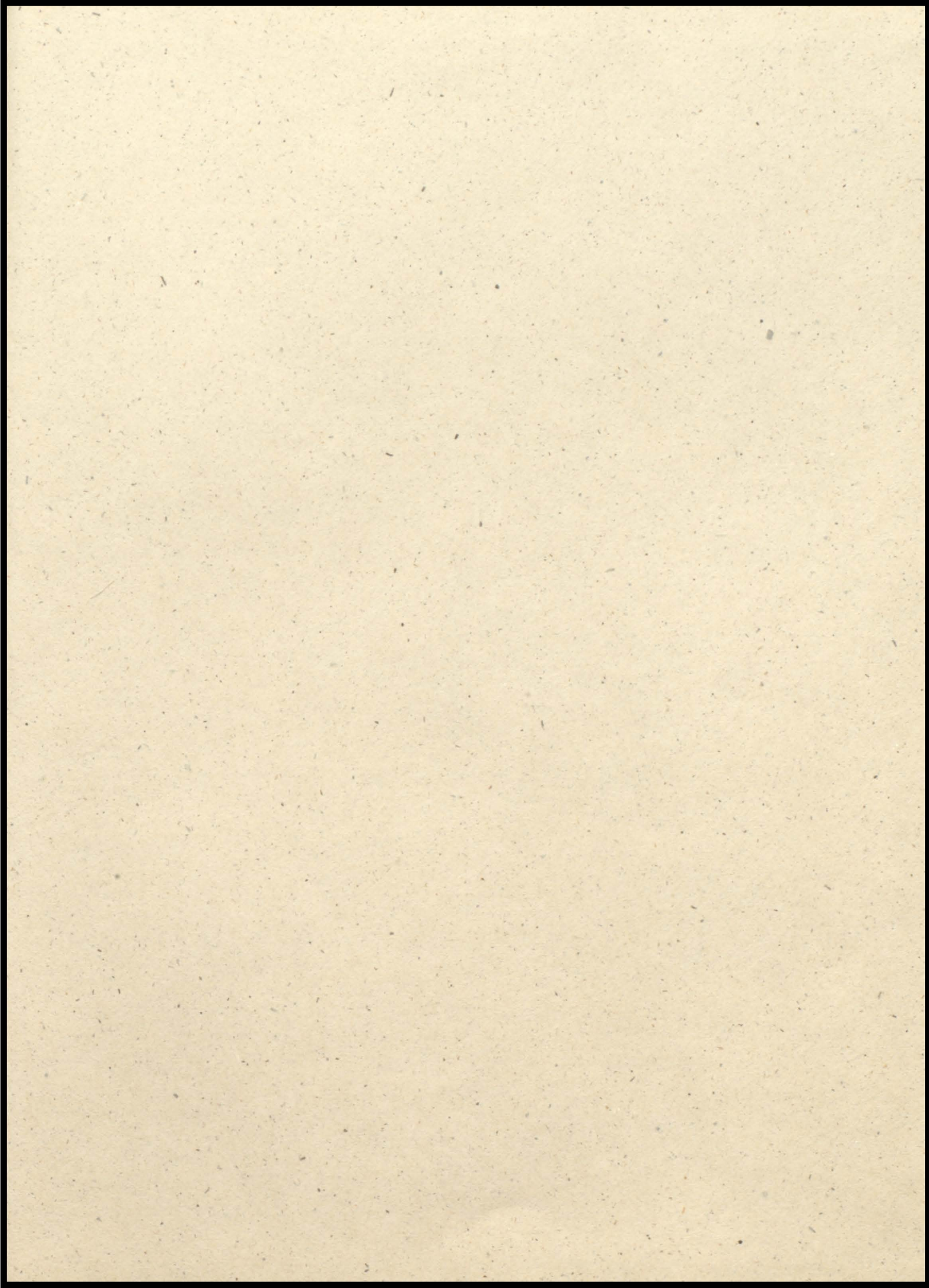

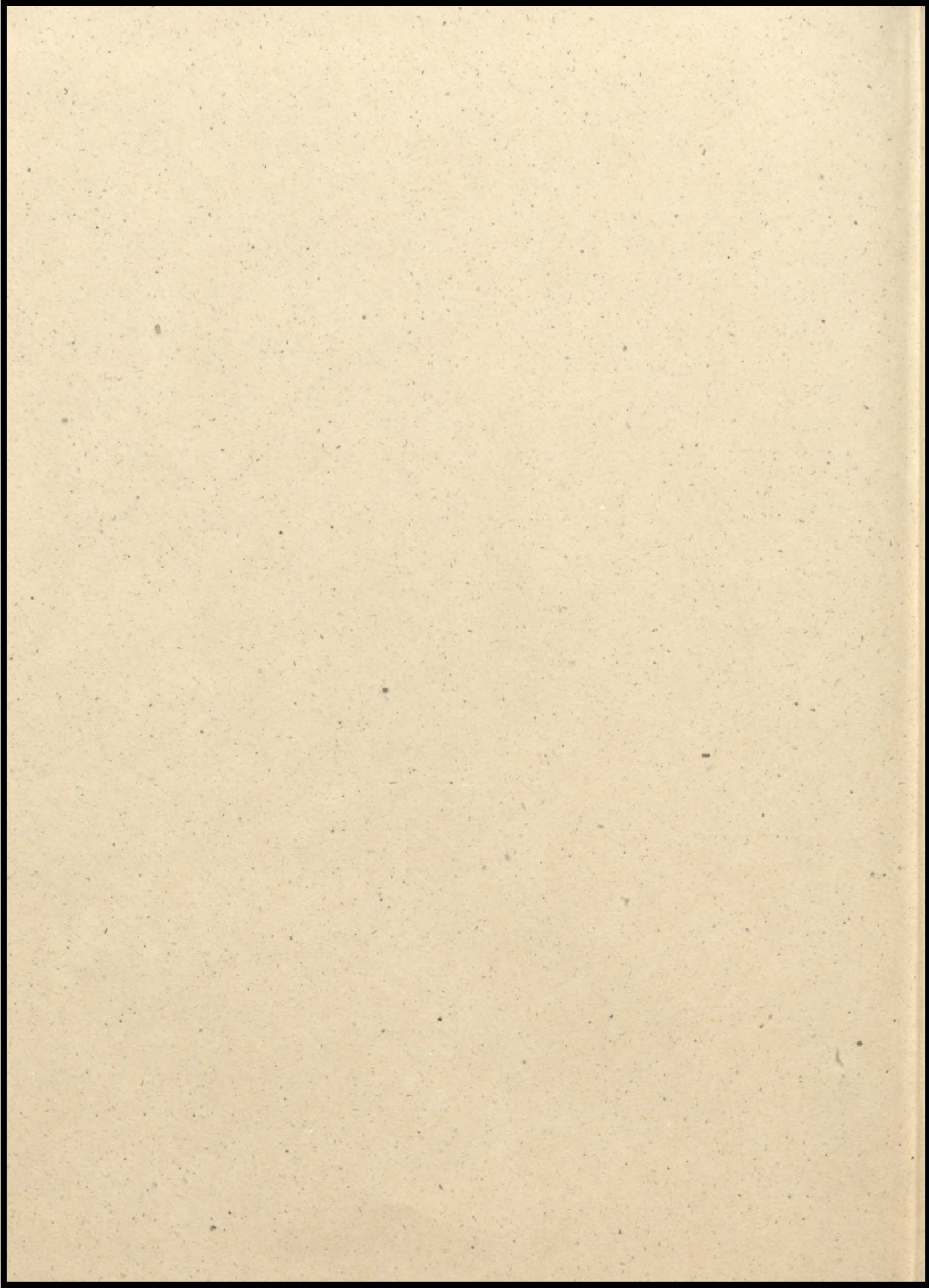

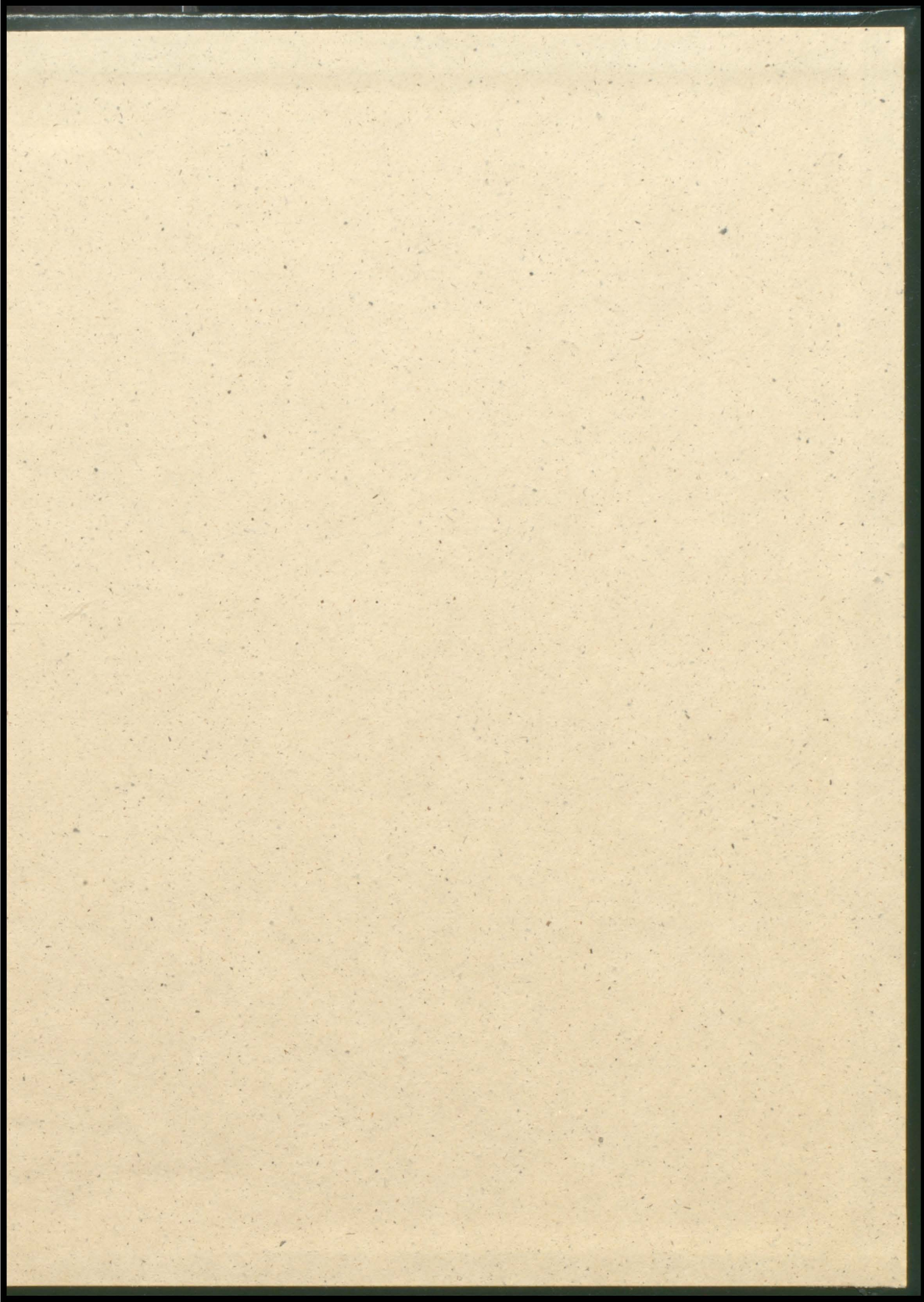

EMMOR
ESTABLISHED 1888